

---

# User and Service Guide

Publication number 54610-97009  
March, 1994 (pdf version Dec 1998)

For Safety Information, Warranties, and Regulatory information,  
see the pages behind the index.

© Copyright Hewlett-Packard Company 1993, 1994  
All Rights Reserved

---

## HP 54610 Oscilloscope

---

# A General-Purpose Oscilloscope

The HP 54610 oscilloscope offers exceptional waveform viewing and measurements in a small, lightweight package. This dual channel, 500 MHz bandwidth oscilloscope is designed for use in labs where high speed analog and digital circuits are being tested. This oscilloscope gives you:

- 500 MHz bandwidth, and 1 ns/div Main and Delayed time bases
- Selectable input impedance
- Protection of the internal 50 ohm load
- Adjustable time nulling to remove the effects of cabling
- Repetitive waveform sampling at up to 10 GSa/sec (20 MSa/sec single shot)
- Viewable external trigger input

This oscilloscope is very easy to use because of its familiar controls and real time display. You can discard your viewing hood as this oscilloscope has none of the viewing problems that are associated with analog oscilloscopes. A bright, crisp display is obtained at all sweep speeds and delayed sweep magnifications. Storage is as simple as pressing a button. View events ahead of the trigger using negative time. Cursors and automatic measurements greatly simplify your analysis tasks.

You can upgrade this oscilloscope for hardcopy or remote control with the addition of an interface module. Built-in pass/fail testing can be added with the addition of one of the Test Automation modules. Unattended waveform monitoring and additional waveform math, such as FFT, can be added with the addition of one of the Measurement/Storage modules.

Bring your scope and PC together with either BenchLink or ScopeLink software. Both BenchLink, which runs under Windows, and ScopeLink, which runs under DOS, allow the easy transfer of scope traces and waveform data to your PC for incorporation into documents or storage.

**Accessories supplied**

- Two 1.5 meter, 10:1 Rugged 500 MHz Probes (HP 10073A)
- Power cord for country of destination
- This *User and Service Guide*

**Accessories available**

- HP 34810A BenchLink Software
- HP 54650A HP-IB Interface Module
- HP 54651A RS-232 Interface Module
- HP 54652A Parallel Interface Module
- HP 54653A ScopeLink Software
- HP 54654A Operator's Training Kit
- HP 54655A and HP 54656A Test Automation Modules
- HP 54657A and HP 54678A Measurement/Storage Modules
- HP 5041-9409 Carrying Case
- HP 5062-7345 Rackmount Kit
- HP 10079A Camera
- HP 10070A 1.5 meter, 1:1 Probe
- HP 10020A Resistive Divider Probe Kit
- HP 10444A 10:1 500 MHz, Low Capacitance Miniature Probe (1.6 m)

**Options available**

- Option 001 RS-03 Magnetic Interference Shielding Added to CRT
- Option 002 RE-02 Display Shield Added to CRT
- Option 005 Enhanced TV/Video Trigger
- Option 101 Accessory Pouch and Front-Panel Cover
- Option 103 Operator's Training Kit (HP 54654A)
- Option 104 Carrying Case (HP 5041-9409)
- Option 105 ScopeLink Software (HP 54653A)
- Option 106 BenchLink Software (HP 34810A)
- Option 090 Deletes Probes
- Option 908 Rackmount Kit (HP 5062-7345)
- Power Cords (see the table of Replaceable Parts in chapter 3, Service)

---

# In This Book

This book is the operating and service manual for the HP 54610 oscilloscope, and contains four chapters.

**First Time Users** Chapter 1 is a quick start guide that gives you a brief overview of the oscilloscope.

**Advanced users** Chapter 2 is a series of exercises that guide you through the operation of the oscilloscope.

**Service technicians** Chapter 3 contains the service information for the oscilloscope. There are procedures for verifying performance, adjusting, troubleshooting, and replacing assemblies in the oscilloscope.

**Reference information** Chapter 4 lists the characteristics of the oscilloscope.




---

# Contents

In This Book v

## **1 The Oscilloscope at a Glance**

-  To connect a signal to the oscilloscope 1-3
- To display a signal automatically 1-5
- To set up the vertical window 1-6
- To set up the time base 1-8
- To trigger the oscilloscope 1-10
- To use roll mode 1-13

## **2 Operating Your Oscilloscope**

- To use delayed sweep 2-3
- To use storage oscilloscope operation 2-6
- To capture a single event 2-8
- To capture glitches or narrow pulses 2-10
- To trigger on a complex waveform 2-12
- To make frequency measurements automatically 2-14
- To make time measurements automatically 2-16
- To make voltage measurements automatically 2-19
- To make cursor measurements 2-23
- To remove cabling errors from time interval measurements 2-27
- To make setup and hold time measurements 2-28
- To view asynchronous noise on a signal 2-29
- To reduce the random noise on a signal 2-31
- To analyze video waveforms 2-34
- To save or recall traces 2-38
- To save or recall front-panel setups 2-39
- To use the XY display mode 2-40



## **3 Service**

- To return the oscilloscope to Hewlett-Packard 3-4
  
- Verifying Oscilloscope Performance 3-5
- To check the output of the DC CALIBRATOR 3-6
- To verify voltage measurement accuracy 3-7

## Contents

- To verify bandwidth 3-10
- To verify horizontal  $\Delta t$  and  $1/\Delta t$  accuracy 3-14
- To verify trigger sensitivity 3-17
  
- Adjusting the Oscilloscope 3-21
  - To adjust the power supply 3-22
  - To perform the self-calibration 3-24
  - To adjust the high-frequency pulse response 3-26
  - To adjust the display 3-28
  
- Troubleshooting the Oscilloscope 3-30
  - To construct your own dummy load 3-31
  - To check out the oscilloscope 3-32
  - To check the LVPS (Low Voltage Power Supply) 3-35
  - To run the internal self-tests 3-36
  
- Replacing Parts in the Oscilloscope 3-39
  - To replace an assembly 3-40
  - To remove the handle 3-45
  - To order a replacement part 3-45

## 4 Performance Characteristics

-  Vertical System 4-2
- Horizontal System 4-4
-  Trigger System 4-5
- XY Operation 4-6
- Display System 4-6
- Acquisition System 4-6
- Advanced Functions 4-7
- Power Requirements 4-7
- General 4-8

## Glossary

## Index



---

The Oscilloscope  
at a Glance

---

# The Oscilloscope at a Glance

One of the first things you will want to do with your new oscilloscope is to become acquainted with its front panel. Therefore, we have written the exercises in this chapter to familiarize you with the controls you will use most often.

The front panel has knobs, grey keys, and white keys. The knobs are used most often and are similar to the knobs on other oscilloscopes. The grey keys bring up softkey menus on the display that allow you access to many of the oscilloscope features. The white keys are instant action keys and menus are not associated with them.

Throughout this book, the front-panel keys are denoted by a box around the name of the key, and softkeys are denoted by a change in the text type. For example, `Source` is the grey front-panel key labeled Source under the trigger portion of the front panel, and `Line` is a softkey. The word `Line` appears at the bottom of the display directly above its corresponding softkey.

The rear cover of this book is a fold-out reference guide. On this cover you will find a diagram of the front panel. Inside the cover is another diagram showing which grey keys to press to bring up the various softkey menus.

Also included inside the rear cover of this book is a status line example. The status line, located at the top of the display, lets you quickly determine the setup of the oscilloscope. In this chapter you will learn to read at a glance the setup of the oscilloscope from the status line.

---

## To connect a signal to the oscilloscope

The HP 54610 is a two-channel, 500 MHz bandwidth oscilloscope with an external trigger input. The input impedance of this oscilloscope is selectable--either 50Ω or 1 MΩ. The 50Ω mode matches 50Ω cables commonly used in making high frequency measurements. This impedance matching gives you the most accurate measurements since reflections are minimized along the signal path. The 1 MΩ mode is for use with probes and for general purpose measurements. The higher impedance minimizes the loading effect of the oscilloscope on the circuit under test. In this exercise you connect a signal to the channel 1 input.

To avoid damage to your new oscilloscope, make sure that the voltage level of the signal you are using is less than or equal to 250 V (dc plus the peak ac). For a complete list of the characteristics see chapter 4, "Performance Characteristics."

---

### CAUTION



Do not exceed 5Vrms in 50Ω mode. When input protection is enabled in 50Ω mode, the 50Ω load will disconnect if greater than 5 Vrms is detected. However the inputs could still be damaged, depending on the time constant of the signal.

---

### CAUTION

The 50Ω input protection mode only functions when the oscilloscope is powered on.

- Use a cable or a probe to connect a signal to channel 1.
- The oscilloscope has automatic probe sensing . If you are using the probes supplied with the oscilloscope, or other probes with probe sensing, then the input impedance and probe attenuation factors will be automatically set up by the oscilloscope when automatic probe sensing is turned on. The default setting is to have automatic probe sensing on. This is indicated by the selection of `Auto n` under the `Probe` softkey, where `n` is 1, 10 or 100.
- If you are not using automatic probe sensing, then follow these next two steps.
- To set the input impedance, press `1` . Select the desired Input impedance of 50Ω or 1MΩ.
- To set the probe attenuation factor press `1` . Select the `Next` Menu softkey. Next toggle the `Probe` softkey to change the attenuation factor to match the probe you are using.

## The Oscilloscope at a Glance

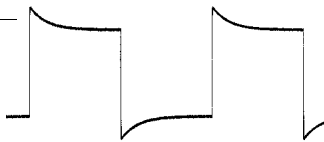
### To connect a signal to the oscilloscope

You should compensate 10:1 probes to match their characteristics to the oscilloscope. A poorly compensated probe can introduce measurement errors. To compensate a probe, follow these steps.

- 1 Connect the 10:1 probe from channel 1 to the front-panel probe adjust signal on the oscilloscope.
- 2 Press `Autoscale`.
- 3 Use a nonmetallic tool to adjust the trimmer capacitor on the probe for the flattest pulse possible as displayed on the oscilloscope.

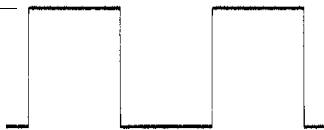
**Figure 1-1**

Overcompensation causes pulse peaking.



**Figure 1-2**

Correct compensation with a flat pulse top.



**Figure 1-3**

Undercompensation causes pulse rolloff.



---

## To display a signal automatically

The oscilloscope has an Autoscale feature that automatically sets up the oscilloscope to best display the input signal. Using Autoscale requires signals with a frequency greater than or equal to 50 Hz and a duty cycle greater than 1%.

When you press the Autoscale key, the oscilloscope turns on and scales all channels that have signals applied, and it selects a time base range based on the trigger source. The trigger source selected is the highest numbered input that has a signal applied. If a signal is connected to the external trigger input on the HP 54610, then it is selected as the trigger source. Autoscale will, in both 50 $\Omega$  and 1M $\Omega$  impedance modes, reset the Coupling to DC, the Bandwidth Limit (BW Lim) to Off, all Verniers to Off, and Signal Inversion (Invert) to Off. Input protection in 50 $\Omega$  mode is not affected by Autoscale.

### 1 Connect a signal to the oscilloscope.

### 2 Press Autoscale.

When you press the Autoscale key, the oscilloscope changes the front-panel setup to display the signal. However, if you pressed the Autoscale key unintentionally, you can use the Undo Autoscale feature. To use this feature, perform the following step.

- Press Setup. Next, press the Undo Autoscale softkey.

The oscilloscope returns to the configuration in effect before you pressed the Autoscale key.

## To set up the vertical window

The following exercise guides you through the vertical keys, knobs, and status line.

### 1 Center the signal on the display with the Position knob.

The Position knob moves the signal vertically, and it is calibrated. Notice that as you turn the Position knob, a voltage value is displayed for a short time indicating how far the ground reference is located from the center of the screen. Also notice that the ground symbol on the right side of the display moves in conjunction with the Position knob.

#### **Measurement hints**

If the channel is dc coupled, you can quickly measure the dc component of the signal by simply noting its distance from the ground symbol.

If the channel is ac coupled, the dc component of the signal is removed allowing you to use greater sensitivity to display the ac component of the signal.

## 2 Change the vertical setup and notice that each change affects the status line differently.

You can quickly determine the vertical setup from the status line in the display.

- Change the vertical sensitivity with the Volts/Div knob and notice that it causes the status line to change.

- Press .

A softkey menu appears on the display, and the channel turns on (or remains on if it was already turned on).

- Toggle each of the softkeys and notice which keys cause the status line to change.

Channels 1 and 2 have a vernier softkey that allows the Volt/Div knob to change the vertical step size in smaller increments. These smaller increments are calibrated, which results in accurate measurements even with the vernier turned on.

- To turn the channel off, either press  a second time or press the left-most softkey.

### Invert operating hint

When you are triggered on the signal you are inverting, the inversion also applies to the trigger signal (what was a rising edge now is a falling edge). If the signal has a 50% duty cycle (square wave or sine wave), the displayed waveform appears not to invert. However, for signals with a duty cycle other than 50%, the displayed waveform does invert as you would expect.

## To set up the time base

The following exercise guides you through the time base keys, knobs, and status line.

- 1 Turn the Time/Div knob and notice the change it makes to the status line.**

The Time/Div knob changes the sweep speed from 1 ns to 5 s in a 1-2-5 step sequence, and the value is displayed in the status line.

- 2 Change the horizontal setup and notice that each change affects the status line differently.**

- Press  .

A softkey menu appears on the display with six softkey choices.

- Toggle each of the softkeys and notice which keys cause the status line to change.



There is also a horizontal vernier softkey that allows the Time/Div knob to change the sweep speed in smaller increments. These smaller increments are calibrated, which results in accurate measurements even with the vernier turned on.

- Turn the Delay knob and notice that its value is displayed in the status line.

The Delay knob moves the main sweep horizontally, and it pauses at 0.00 s, mimicking a mechanical detent. At the top of the graticule is a solid triangle (▼) symbol and an open triangle (∇) symbol. The ▼ symbol indicates the trigger point and it moves in conjunction with the Delay knob. The ∇ symbol indicates the time reference point. If the time reference softkey is set to left, the ∇ is located one graticule in from the left side of the display. If the time reference softkey is set to center, the ∇ is located at the center of the display. The delay number tells you how far the reference point ∇ is located from the trigger point ▼.

All events displayed left of the trigger point ▼ happened before the trigger occurred, and these events are called pretrigger information or negative time. You will find this feature very useful because you can now see the events that led up to the trigger point. Everything to the right of the trigger point ▼ is called posttrigger information. The amount of delay range (pretrigger and posttrigger information) available is dependent on the sweep speed selected. See "Horizontal System" in chapter 4, for more details.

## To trigger the oscilloscope

The following exercise guides you through the trigger keys, knobs, and status line.

**1 Turn the trigger Level knob and notice the changes it makes to the display.**

As you turn the Level knob or press a trigger menu key, for a short time two things happen on the display. First, the trigger level is displayed in inverse video. If the trigger is dc coupled, it is displayed as a voltage. If the trigger is ac coupled or if LF reject was selected, it is displayed as a percentage of the trigger range. Second, if the trigger source is turned on, a line is displayed showing the location of the trigger level (as long as ac coupling or low frequency reject are not selected).

**2 Change the trigger setup and notice that each change affects the status line differently.**

- Press `Source` .

A softkey menu appears on the display showing the trigger source choices.

- Toggle each of the softkeys and notice that each key causes the status line to change.

**3 The HP 54610 has a viewable external trigger, which is useful for making timing measurements. It is also useful for ensuring that the trigger level is not set to a value that results in trigger instability which causes display to appear unstable. One example of this measurement challenge is the ringing on a fast signal.**

- Press `External Trigger` .

A softkey menu appears on the display showing the external trigger choices.

Toggle each of the softkeys, turn the knob, and notice how the display changes.

- Press `Mode` .

A softkey menu appears on the display with five trigger mode choices.

- Toggle the `Single` and `TV` softkeys and notice that they affect the status line differently. (You can only select `TV` if the trigger source is either channel 1 or 2.)

When the oscilloscope is triggering properly, the trigger mode portion of the status line is blank.

#### What happens if the oscilloscope loses trigger?

If `Auto Level` is the trigger mode, `Auto` flashes in the status line. If `dc` coupled, the oscilloscope resets the trigger level to the center of the signal. If `ac` coupled, the oscilloscope resets the trigger level to halfway between the minimum and maximum amplitudes as displayed on the screen. In addition, every time you press the `Auto Level` softkey, the oscilloscope resets the trigger level.

If `Auto` is the trigger mode, `Auto` flashes in the status line and the oscilloscope free runs.

If either `Normal` or `TV` is the trigger mode, the trigger setup flashes in the status line.

## To trigger the oscilloscope

- Press Slope/Coupling .

A softkey menu appears on the display. If you selected Auto level, Auto, Normal, or Single as a trigger mode, six softkey choices are displayed. If you selected TV as a trigger source, five other softkey choices are available.

- Toggle each of the softkeys and notice which keys affect the status line.
- On the HP 54610, the external trigger input is selectable as ac or dc coupled or ground.

### 3 Adjust the Holdoff knob and observe how it changes the display.

Holdoff keeps the trigger from rearming for an amount of time that you set. Holdoff is often used to stabilize the display of complex waveforms. The Holdoff range is from 200.0 ns to about 13.5 s. When you adjust the Holdoff knob, the current holdoff time is briefly displayed in inverse video near the bottom of the display. For an example of using Holdoff, refer to the section, "To trigger on a complex waveform" on page 2-12.

#### **To set a long holdoff time, go to a slower sweep speed.**

The value used to increment the holdoff depends upon the sweep speed or time/div selection. However, the actual holdoff value is a fixed number; it is not a percentage of sweep speed. For a time/div setting of 5 ns/div, the holdoff increment is about 50 ns. For a time/div setting of 5 s/div, the holdoff increment is about 100 ms.

---

## To use roll mode

Roll mode continuously moves data across the display from right to left. Roll mode allows you to see dynamic changes on low frequency signals, such as when you adjust a potentiometer. Two frequently used applications of roll mode are transducer monitoring and power supply testing.

- 1 Press **Mode**. Then press the **Auto Lvl** or **Auto** softkey.
- 2 Press **Main/Delayed**.
- 3 Press the **Roll** softkey.

The oscilloscope is now untriggered and runs continuously. Also notice that the time reference softkey selection changes to center and right.

- 4 Press **Mode**. Then press the **Single** softkey.

The oscilloscope fills either 1/2 of the display if **Center** is selected for the time reference, or 9/10 of the display if **Right** is selected for the time reference, then it searches for a trigger. After a trigger is found, the remainder of the display is filled. Then the oscilloscope stops acquiring data. You can also make automatic measurements in the roll mode. Notice that the oscilloscope briefly interrupts the moving data while it makes the measurement. The acquisition system does not miss any data during the measurement. The slight shift in the display after the measurement is complete is that of the display catching up to the acquisition system.

### Roll mode operating hints

Math functions, averaging, and peak detect are not available.

Holdoff and horizontal delay are not active.

Both a free running (nontriggered) display and a triggered display (available in the single mode only) are available.

It is available at sweep speeds of 200 ms/div and slower.



---

# Operating Your Oscilloscope

---

# Operating Your Oscilloscope

By now you are familiar with the VERTICAL, HORIZONTAL, and TRIGGER groups of the front-panel keys. You should also know how to determine the setup of the oscilloscope by looking at the status line. If you are unfamiliar with this information, we recommend you read chapter 1, "The Oscilloscope at a Glance."

This chapter takes you through two new groups of front-panel keys: STORAGE, and the group of keys that contains the Measure, Save/Recall, and Display keys. You will also add to your knowledge of the HORIZONTAL keys by using delayed sweep.

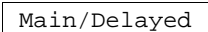
We recommend you perform all of the following exercises so you become familiar with the powerful measurement capabilities of your oscilloscope.





---

## To use delayed sweep

Delayed sweep is a magnified portion of the main sweep. You can use delayed sweep to locate and horizontally expand part of the main sweep for a more detailed (high resolution) analysis of signals. The following steps show you how to use delayed sweep. Notice that the steps are very similar to operating the delayed sweep in analog oscilloscopes.

- 1 Connect a signal to the oscilloscope and obtain a stable display.**
- 2 Press .**
- 3 Press the Delayed softkey.**

The screen divides in half. The top half displays the main sweep, and the bottom half displays an expanded portion of the main sweep. This expanded portion of the main sweep is called the delayed sweep. The top half also has two solid vertical lines called markers. These markers show what portion of the main sweep is expanded in the lower half. The size and position of the delayed sweep are controlled by the Time/Div and Delay knobs. The Time/Div next to the  symbol is the delayed sweep sec/div. The delay value is displayed for a short time at the bottom of the display.

- To display the delay value of the delayed time base, either press  or turn the Delay knob.
- To change the main sweep Time/Div, you must turn off the delayed sweep.

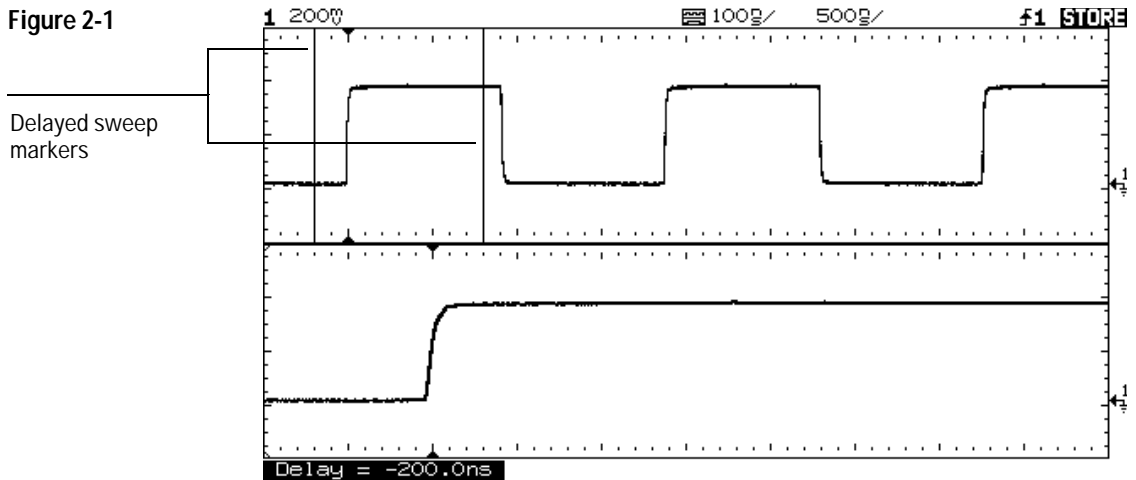
## Operating Your Oscilloscope

### To use delayed sweep

Since both the main and delayed sweeps are displayed, there are half as many vertical divisions so the vertical scaling is doubled. Notice the changes in the status line.

- To display the delay time of the delayed sweep, either press `Main/Delayed` or turn the delay knob. The delay value is displayed near the bottom of the display.
- 4 Set the time reference (Time Ref) to either left (Lft) or center (Cntr).

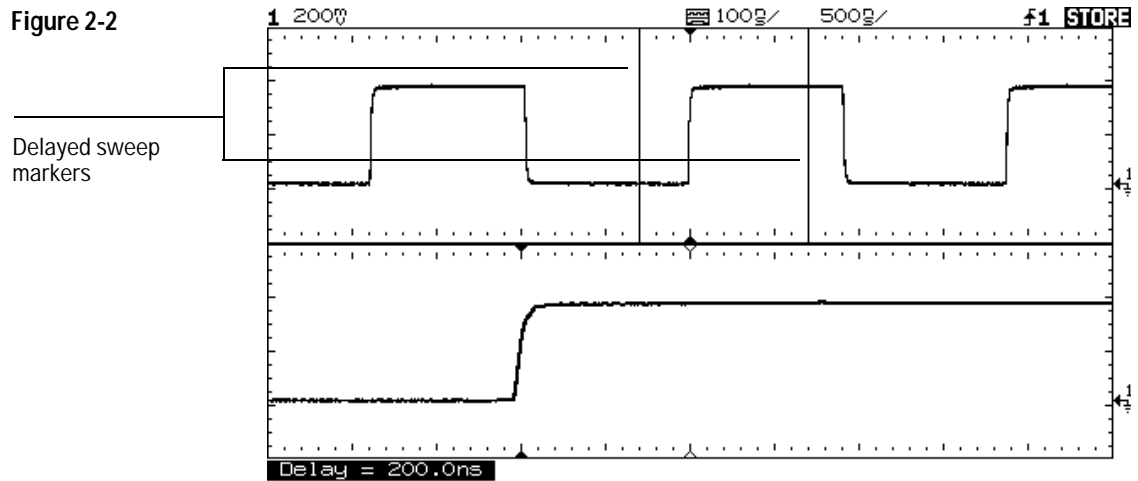
Figure 2-1 shows the time reference set to left. The operation is like the delayed sweep of an analog oscilloscope, where the delay time defines the start of the delayed sweep.



Time reference set to left

Figure 2-2 shows the time reference set to center. Notice that the markers expand around the area of interest. You can place the markers over the area of interest with the delay knob, then expand the delayed sweep with the time base knob to increase the resolution.

Figure 2-2



Time reference set to center

## To use storage oscilloscope operation

There are four front-panel storage keys. They are white instant action keys that change the operating mode of the oscilloscope. The following steps demonstrate how to use these storage keys.

- 1** Connect a signal to the oscilloscope and obtain a stable display.
- 2** Press  .

Notice that STORE replaces RUN in the status line.

For easy viewing, the stored waveform is displayed in half bright and the most recent trace is displayed in full bright. Autostore is useful in a number of applications.

- Displaying the worst-case extremes of varying waveforms
- Capturing and storing a waveform
- Measuring noise and jitter
- Capturing events that occur infrequently

**3 Using the position knob in the Vertical section of the front panel, move the trace up and down about one division.**

Notice that the last acquired waveform is in full bright and the previously acquired waveforms are displayed in half bright.

- To characterize the waveforms, use the cursors. See "To make cursor measurements" on page 2-23.
- To clear the display, press  .
- To exit the Autostore mode, press either  or  .

**Summary of storage keys**

*Run* – The oscilloscope acquires data and displays the most recent trace.

*Stop* – The display is frozen.

*Autostore* – The oscilloscope acquires data, displaying the most recent trace in full bright and previously acquired waveforms in half bright.

*Erase* – Clears the display.

## To capture a single event

To capture a single event, you need some knowledge of the signal in order to set up the trigger level and slope. For example, if the event is derived from TTL logic, a trigger level of 2 volts should work on a rising edge. The following steps show you how to use the oscilloscope to capture a single event.

- 1** Connect a signal to the oscilloscope.
- 2** Set up the trigger.
  - Press  . Select a trigger source with the softkeys.
  - Press  . Select a trigger slope with the softkeys.
  - Turn the Level knob to a point where you think the trigger should work.
- 3** Press  , then press the **Single** softkey.
- 4** Press  to clear previous measurements from the display.
- 5** Press  .

Pressing the Run key arms the trigger circuit. When the trigger conditions are met, data appears on the display representing the data points that the oscilloscope obtained with one acquisition. Pressing the Run key again rearms the trigger circuit and erases the display.

**6 If you need to compare several single-shot events, press `Autostore`.**

Like the Run key, the Autostore key also arms the trigger circuit. When the trigger conditions are met, the oscilloscope triggers. Pressing the Autostore key again rearms the trigger circuit without erasing the display. All the data points are retained on the display in half bright with each trigger allowing you to easily compare a series of single-shot events.

After you have acquired a single-shot event, pressing a front-panel key, softkey, or changing a knob can erase the event from the display. If you press the Stop key, the oscilloscope will recover the event and restore the oscilloscope settings.

- To clear the display, press `Erase`.
- To exit the Autostore mode, press either `Run` or `Autostore`. Notice that RUN replaces STORE in the status line, indicating that the oscilloscope has exited the Autostore mode.

#### Operating hint

The single-shot bandwidth is 2 MHz for single-channel operation, and 1 MHz for two-channel operation. There are twice as many sample points per waveform on the one-channel acquisition than on the two-channel acquisition.

## To capture glitches or narrow pulses

A glitch is a rapid change in the waveform that is usually narrow as compared to the waveform. This oscilloscope has two modes of operation that you can use for glitch capture: peak detect and Autostore.

- 1 Connect a signal to the oscilloscope and obtain a stable display.**
- 2 Find the glitch.**

Use peak detect for narrow pulses or glitches that require sweep speeds slower than 50  $\mu\text{s}/\text{div}$ .

- To select peak detect, press Display. Next, press the Peak Det softkey.

Peak detect operates at sweep speeds from 5 s/div to 50  $\mu\text{s}/\text{div}$ . When operating, the initials Pk are displayed in the status line in inverse video. At sweep speeds faster than 50  $\mu\text{s}/\text{div}$ , the Pk initials are displayed in normal video, which indicates that peak detect is not operating.



Use Autostore for the following cases: waveforms that are changing, waveforms that you want to view and compare with stored waveforms, and narrow pulses or glitches that occur infrequently but require the use of sweep speeds outside the range of peak detect.

- Press  .

You can use peak detect and Autostore together. Peak detect captures the glitch, while Autostore retains the glitch on the display in half bright video.

### 3 Characterize the glitch with delayed sweep.

Peak detect functions in the main sweep only, not in the delayed sweep. To characterize the glitch with delayed sweep follow these steps.

- Press  . Next press the Delayed softkey.
- To obtain a better resolution of the glitch, expand the time base.
- To set the expanded portion of the main sweep over the glitch, use the Delay knob.
- To characterize the glitch, use the cursors or the automatic measurement capabilities of the oscilloscope.

## To trigger on a complex waveform

The difficulty in viewing a complex waveform is triggering on the signal. Figure 2-3 shows a complex waveform that is not synchronized with the trigger.

The simplest trigger method is to trigger the oscilloscope on a sync pulse that is associated with the waveform. See "To trigger the oscilloscope" on page 1-10. If there is no sync pulse, use the following procedure to trigger on a periodic complex waveform.

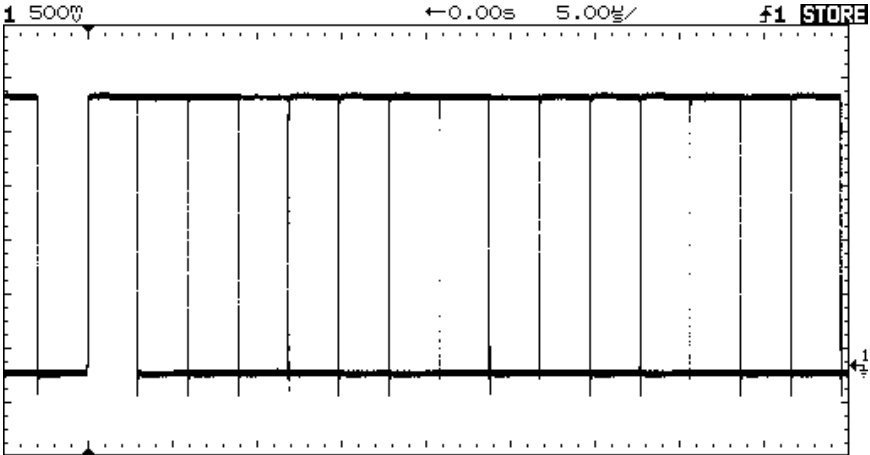
- 1 Connect a signal to the oscilloscope.**
- 2 Set the trigger level to the middle of the waveform.**
- 3 Adjust the Holdoff knob to synchronize the trigger of the oscilloscope with the complex waveform.**

By setting the Holdoff to synchronize the trigger, the oscilloscope ignores the trigger that results in figure 2-3, and waits for the trigger that results in figure 2-4. Also notice in figure 2-3 that the trigger is stable, but the waveform is not synchronized with the trigger.

### Holdoff operating hints

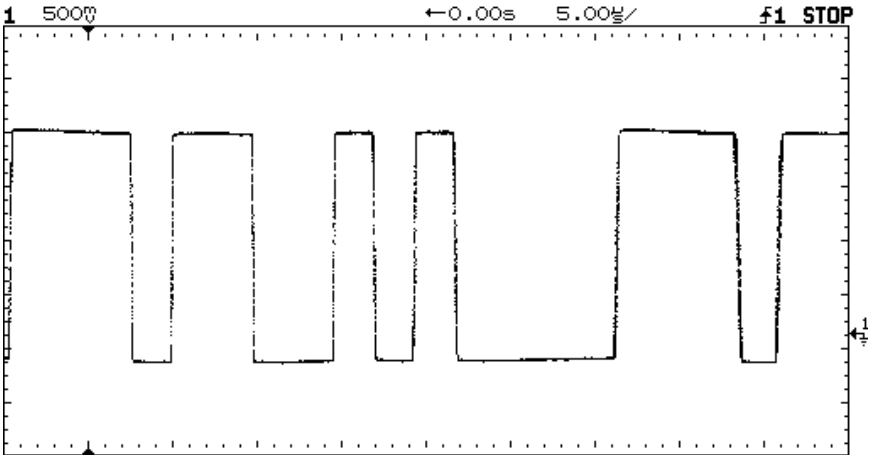
- 1** The advantage of digital holdoff is that it is a fixed number. As a result, changing the time base settings does not affect the holdoff number; so, the oscilloscope remains triggered. In contrast, the holdoff in analog oscilloscopes is a function of the time base setting making it necessary to readjust the holdoff each time you change the time base setting.
- 2** The rate of change of the holdoff adjustment knob depends on the time base setting you have selected. If you need a lengthy holdoff setting, increase the time/div setting on the time base, then make your coarse holdoff adjustment. Now switch back to the original time/div setting and make the fine adjustment to reach the exact amount you want.

Figure 2-3



Stable trigger, but the waveform is not synchronized with the trigger

Figure 2-4



Holdoff synchronizes the waveform with the trigger

## To make frequency measurements automatically

The automatic measurement capability of the oscilloscope makes frequency measurements easy, as the following steps demonstrate.

- 1** Connect a signal to the oscilloscope and obtain a stable display.
- 2** Press .

A softkey menu appears with six softkey choices.

- 3** Toggle the `Source` softkey to select a channel for the frequency measurement.
- 4** Press the `Freq` softkey.

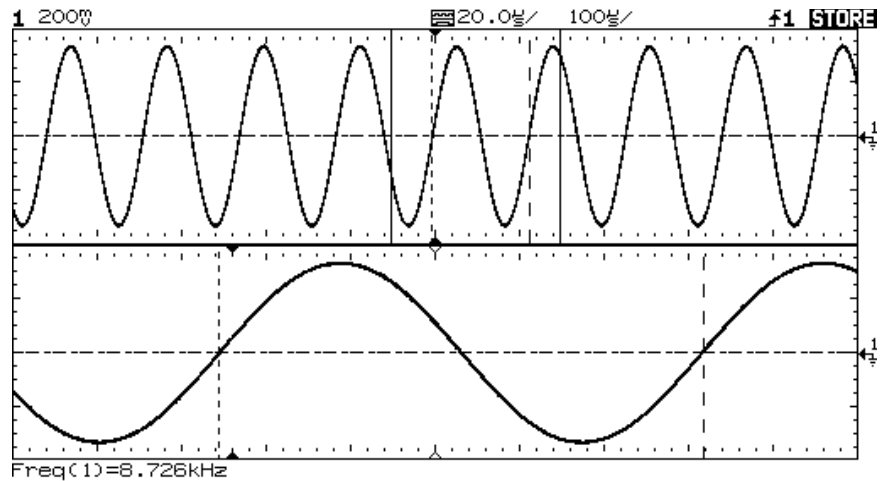
The oscilloscope automatically measures the frequency and displays the result on the lower line of the display. The number in parentheses after the word `Freq` is the number of the channel that the oscilloscope used for the measurement. The oscilloscope retains in memory and displays the three most current measurement results. If you make a fourth measurement, the left-most result is dropped.

If the Show Meas softkey is turned on, cursors are displayed on the waveform that show the measurement points for the right-most measurement result. If you select more than one measurement, you can show a previous measurement by reselecting the measurement.

- To find the Show Meas softkey, press the Next Menu softkey.

The oscilloscope makes automatic measurements on the first displayed event. Figure 2-5 shows how to use delayed sweep to isolate an event for a frequency measurement. If the measurement is not possible in the delayed time base mode, then the main time base is used. If the waveform is clipped, it may not be possible to make the measurement.

Figure 2-5



Delayed time base isolates an event for a frequency measurement

---

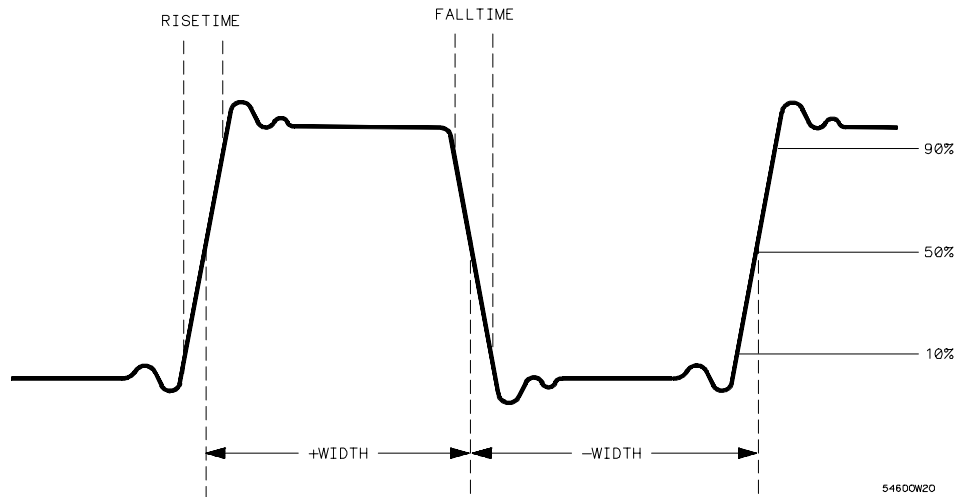
## To make time measurements automatically

You can measure the following time parameters with the oscilloscope: frequency, period, duty cycle, width, rise time, and fall time. The following exercise guides you through the Time keys by making a rise time measurement. Figure 2-6 shows a pulse with some of the time measurement points.

**1 Connect a signal to the oscilloscope and obtain a stable display.**

When the signal has a well-defined top and bottom, the rise time and fall time measurements are made at the 10% and 90% levels. If the oscilloscope cannot find a well-defined top or bottom, the maximum and minimum levels are used to calculate the 10% and 90% points. These levels are shown on page 2-19 in figures 2-8 and 2-9.

Figure 2-6



**2** Press Time .

A softkey menu appears with six softkey choices. Three of the softkeys are time measurement functions.

**Source** Selects a channel for the time measurement.

**Time Measurements** Three time measurement choices are available: **Freq** (frequency), **Period**, and **Duty Cy** (duty cycle). These measurements are made at the 50% levels. Refer to figure 2-6.

**Clear Meas** (clear measurement) Erases the measurement results and removes the cursors from the display.

**Next Menu** Replaces the softkey menu with six additional softkey choices.

**3** Press the **Next Menu** softkey.

Another time measurement softkey menu appears with six additional choices. Four of the softkeys are time measurement functions.

**Show Meas** (show measurement) Displays the horizontal and vertical cursors where the measurement was taken.

## Operating Your Oscilloscope To make time measurements automatically

**Time Measurements** Four additional time measurement choices are available; +width, [Pulse Width] -width, Rise Time, and Fall Time. Width measurements are made at the 50% levels, whereas rise time and fall time measurements are made at the 10% to 90% levels.

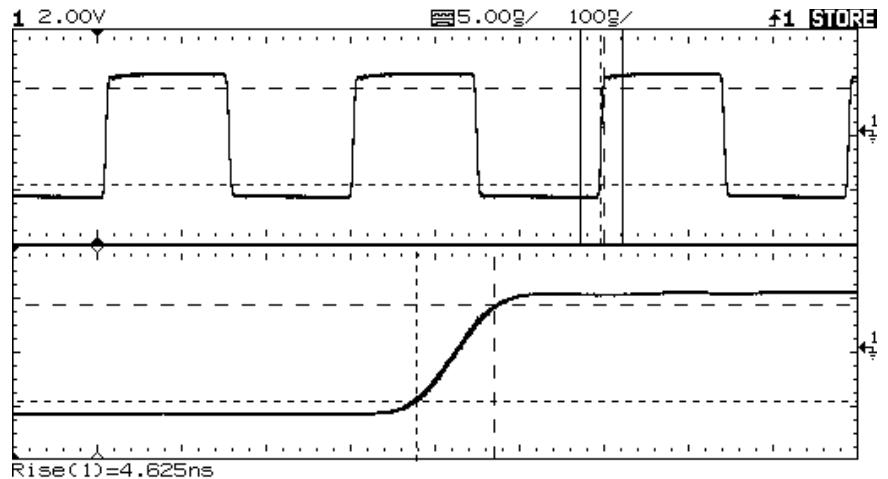
**Previous Menu** Returns to the previous softkey menu.

### 4 Press the Rise Time softkey.

The oscilloscope automatically measures the rise time of the signal and displays the result on the display.

The oscilloscope makes automatic measurements on the first displayed event. Figure 2-7 shows how to use delayed sweep to isolate an edge for a rise time measurement.

Figure 2-7



Delayed sweep isolates a leading edge for a rise time measurement

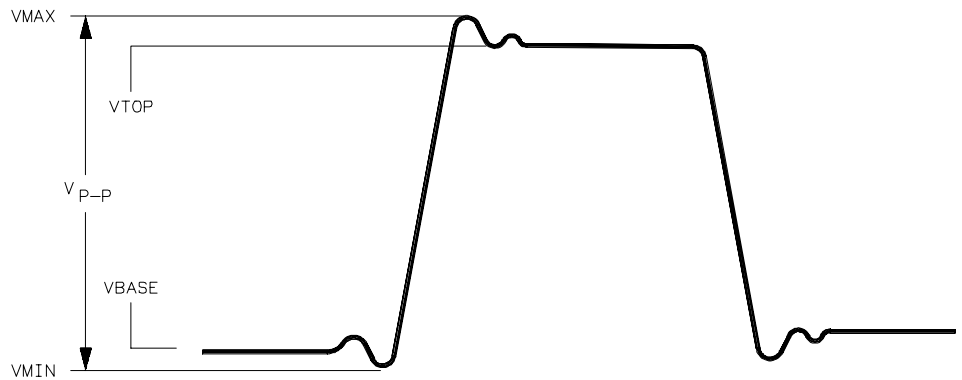


---

## To make voltage measurements automatically

You can measure the following voltage parameters automatically with the oscilloscope: peak-to-peak, average, rms, maximum, minimum, top, and base. The following exercise guides you through the Voltage keys by making an rms voltage measurement. Figures 2-8 and 2-9 show pulses with some of the voltage measurement points.

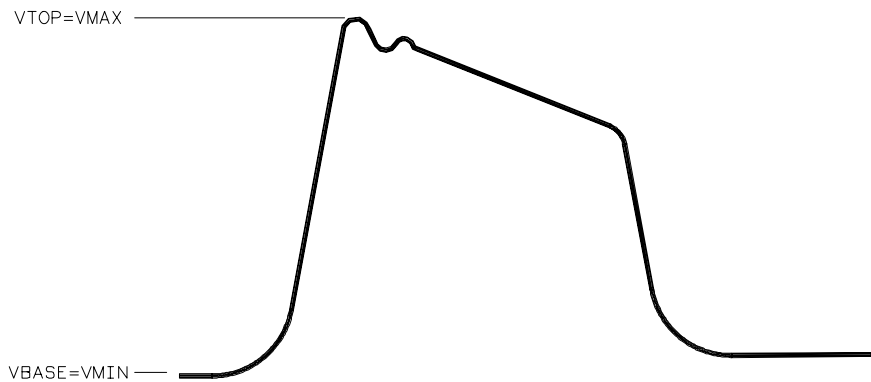
Figure 2-8



54600W21

Pulse where the top and bottom are well-defined

Figure 2-9



54600W22

Pulse where the top and bottom are not well-defined

Operating Your Oscilloscope  
**To make voltage measurements automatically**

- 1** Connect a signal to the oscilloscope and obtain a stable display.
- 2** Press  .

A softkey menu appears with six softkey choices. Three of the softkeys are voltage measurement functions.

**Source** Selects a channel for the voltage measurement.

**Voltage Measurements** Three voltage measurement choices are available:  $V_{p-p}$ ,  $V_{avg}$ , and  $V_{rms}$ . The measurements are determined by voltage histograms of the signal.

**Clear Meas** (clear measurement) Erases any measurement results from the display, and removes the horizontal and vertical cursors from the display.

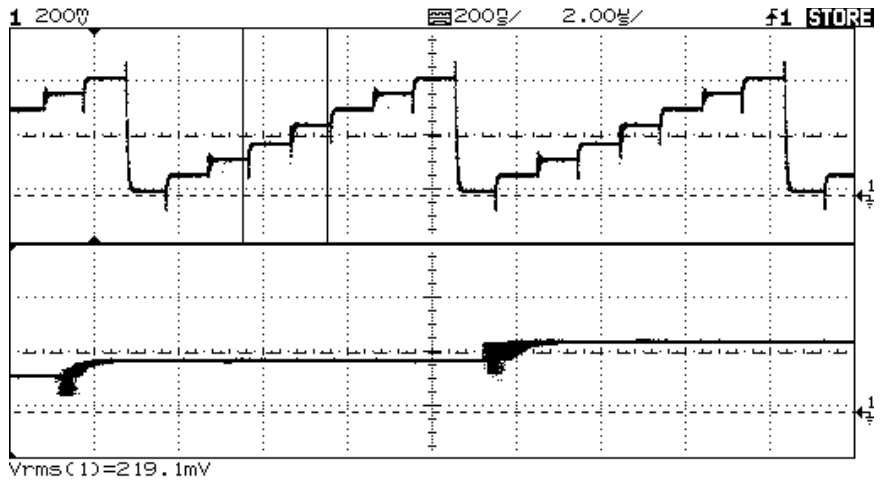
**Next Menu** Replaces the softkey menu with six additional softkey choices.

**3 Press the  $V_{RMS}$  softkey.**

The oscilloscope automatically measures the rms voltage and displays the result on the display.

The oscilloscope makes automatic measurements on the first pulse or period in the display. Figure 2-10 shows how to use delayed sweep to isolate a pulse for an rms measurement.

Figure 2-10



Delayed sweep isolates an area of interest for an rms voltage measurement

**4 Press the Next Menu softkey.**

Another voltage measurement softkey menu appears with six additional choices. Four of the softkeys are voltage measurement functions.

**Show Meas** (show measurement) Displays the horizontal and vertical cursors that show where the measurement was taken on the signal.

**Voltage Measurements** Four additional voltage measurement choices are available:  $V_{max}$ ,  $V_{min}$ ,  $V_{top}$ ,  $V_{base}$ .

**Previous Menu** Returns to the previous softkey menu.

---

## To make cursor measurements

The following steps guide you through the front-panel Cursors key. You can use the cursors to make custom voltage or time measurements on the signal. Examples of custom measurements include rise time measurements from reference levels other than 10-90%, frequency and width measurements from levels other than 50%, channel-to-channel delay measurements, and voltage measurements. See figures 2-11 through 2-16 for examples of custom measurements.

- 1 Connect a signal to the oscilloscope and obtain a stable display.
- 2 Press **Cursors**.

A softkey menu appears with six softkey choices. Four of the softkeys are cursor functions.

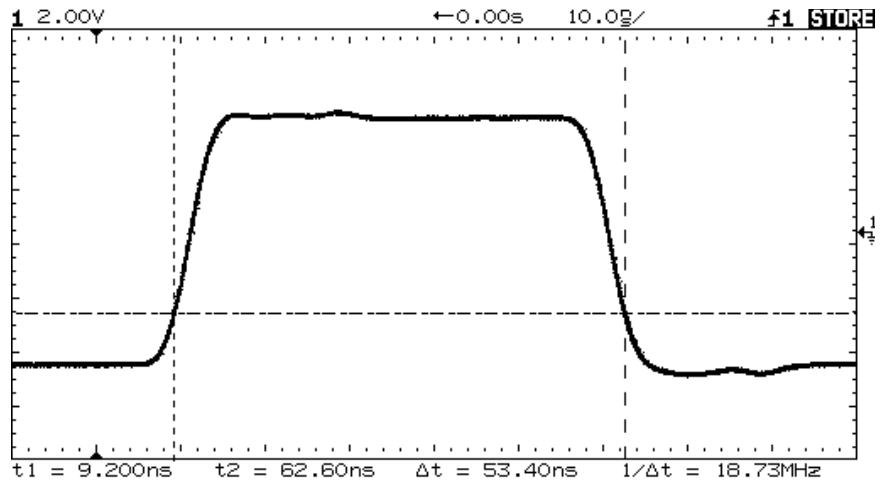
**Source** Selects a channel for the voltage cursor measurements.

**Active Cursor** There are four cursor choices: V1, and V2 are voltage cursors, while  $t_1$ , and  $t_2$  are time cursors. Use the knob below the **Cursors** key to move the cursors. When you press the V1 and V2 softkeys simultaneously or the  $t_1$  and  $t_2$  softkeys simultaneously, the cursors move together.

**Clear Cursors** Erases the cursor readings and removes the cursors from the display.

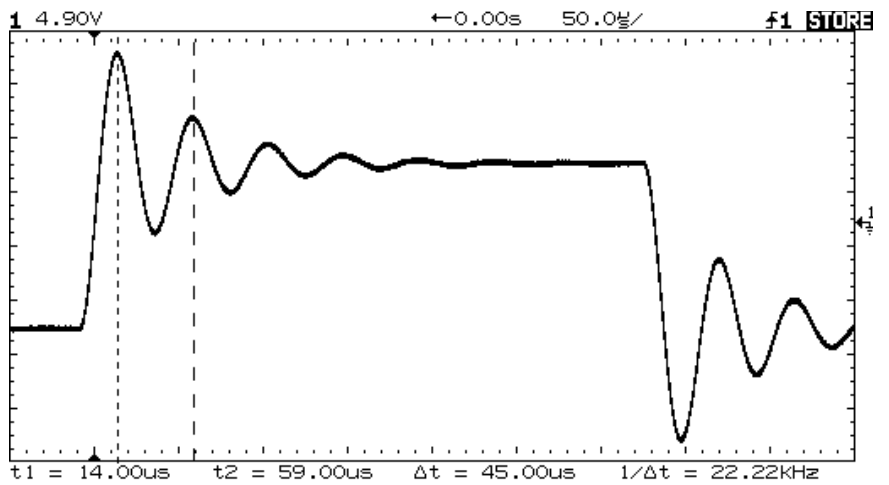
Operating Your Oscilloscope  
To make cursor measurements

Figure 2-11



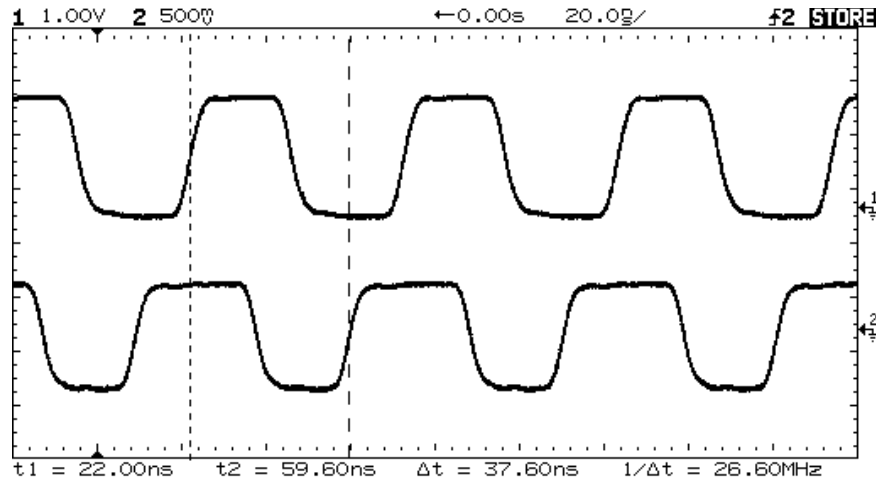
Cursors used to measure pulse width at levels other than the 50% points

Figure 2-12



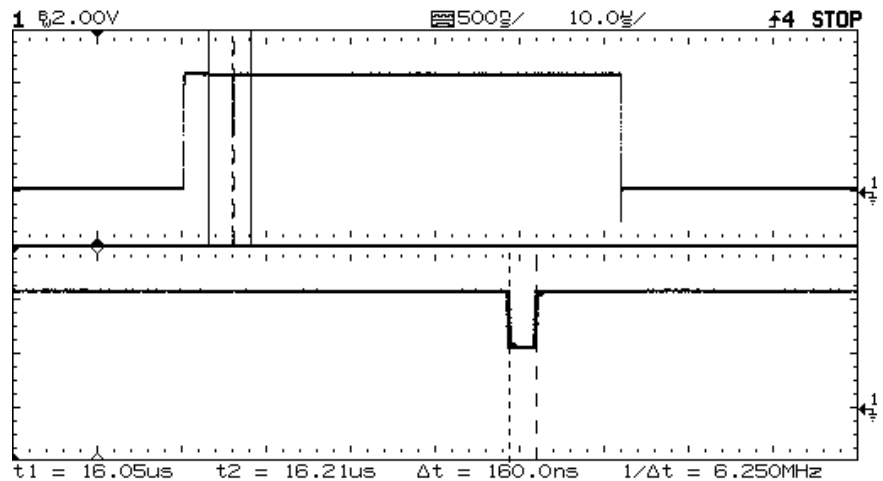
Cursors used to measure the frequency of the ringing on a pulse

Figure 2-13



Cursors used to make channel-to-channel delay measurements

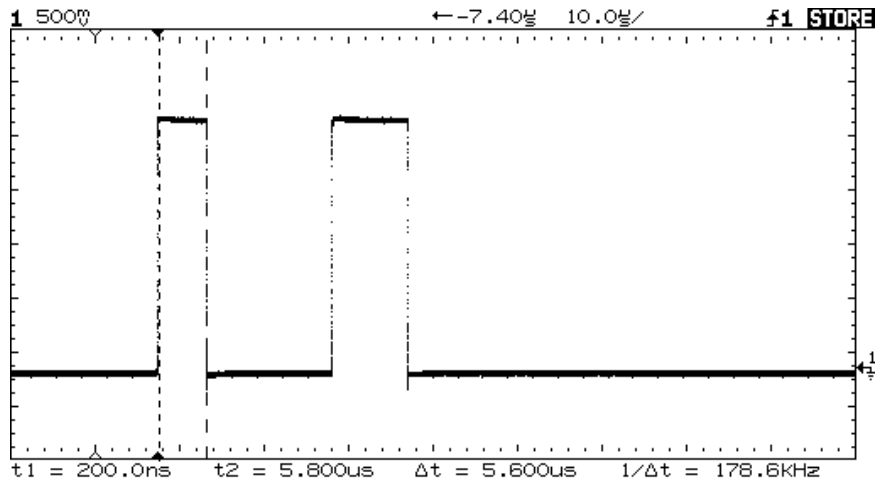
Figure 2-14



The cursors track delayed sweep. Expand the display with delayed sweep, then characterize the event of interest with the cursors.

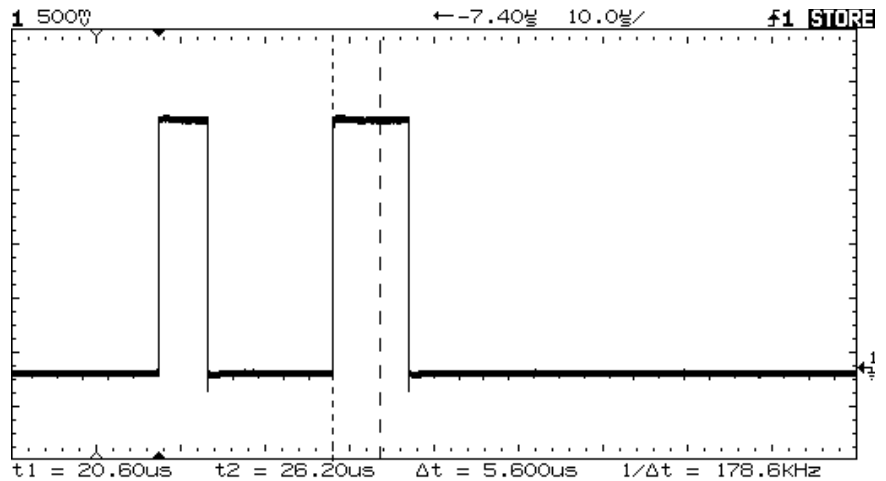
Operating Your Oscilloscope  
To make cursor measurements

Figure 2-15



Pressing t1 and t2 softkeys simultaneously causes the cursors to move together when the cursor knob is adjusted.

Figure 2-16



By moving the cursors together, you can check for pulse width variations in a pulse train, as figures 2-15 and 2-16 show.



## To remove cabling errors from time interval measurements

When measuring time intervals in the nanosecond range, small differences in cable length can totally obscure the measurement. The following exercise shows how to remove errors that different cable lengths or characteristics introduce to your measurement. The Skew control makes it possible to remove this offset error from your measurement.

This process is also referred to as deskewing.

- 1** Select **Time Reference to Center**, with the **Graticule** turned on.
- 2** Connect the channels to be nulled to a common test point and obtain a stable display. A fast edge is a good choice.
- 3** Press **Print/Utility**, then select the **Self Cal** menu. This gives you access to the calibration and skew adjustments.
- 4** Select **Skew 1 > 2** to adjust channel 2 with respect to channel 1. Rotate the knob to bring the channels into time alignment. This nullifies the cable delay.
- 5** Select **Skew 1 > E** to adjust the External Trigger with respect to Channel 1. Rotate the knob to bring these channels into time alignment..

**Note:** This adjustment is not affected by pressing **Autoscale**. Only the default setup will return the skew values to zero seconds.

---

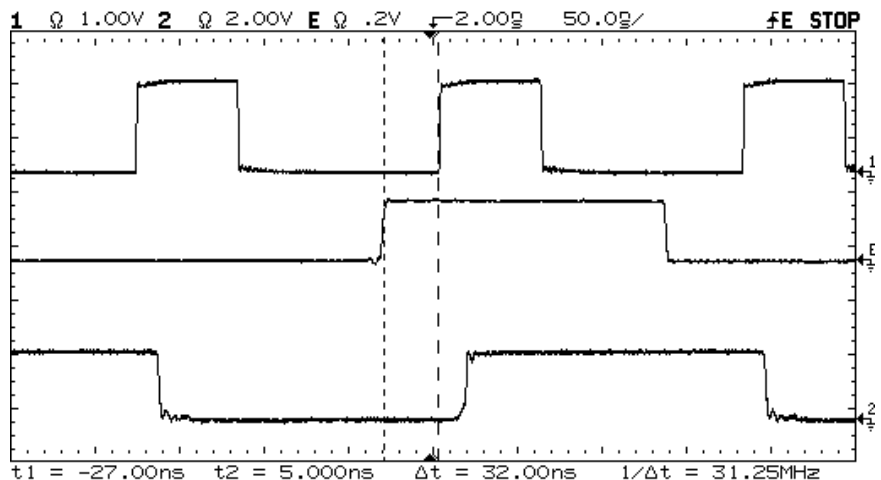
## To make setup and hold time measurements

One method of testing a device for its setup and hold times limits uses a variable pulse generator to provide the time varying pulses, and an oscilloscope to monitor when the setup and hold times are violated.

Selecting the trigger for this measurement is important. The clock is not a good choice for a trigger because it is not unique. Triggering on the Q output results in loss of trigger when the setup and hold time is violated. Triggering on the D input is the best choice. In this example the flip flop is clocked on the rising edge.

- 1 Set time skew to remove errors introduced by different cables for this time interval measurement.
- 2 Connect the D input of the flip-flop to the External Trigger on your oscilloscope. Set the scope to trigger on the rising edge.
- 3 Connect the flip-flop's clock signal to channel 1.
- 4 Connect the Q output to channel 2 of the oscilloscope.
- 5 Press  , then turn on the External Trigger so that it is viewable.
- 6 Use the time cursors to measure the difference between the rising edge of the clock and the D input to determine setup and hold time.

Figure 2-17



Setup time measurement: channel 1 = clock, channel 2 = Q output, and External Trigger = D input

---

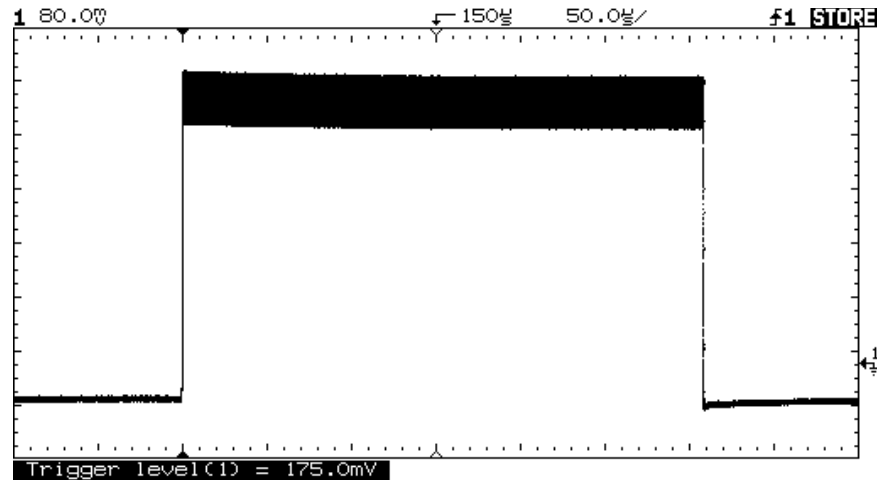
## To view asynchronous noise on a signal

The following exercise shows how to use the oscilloscope to view asynchronous noise on a signal that is not synchronous to the period of the waveform.

- 1 Connect a noisy signal to the oscilloscope and obtain a stable display.

Figure 2-18 shows a waveform with asynchronous noise at the top of the pulse.

Figure 2-18



Asynchronous noise at the top of the pulse

Operating Your Oscilloscope  
To view asynchronous noise on a signal

2 Press  .

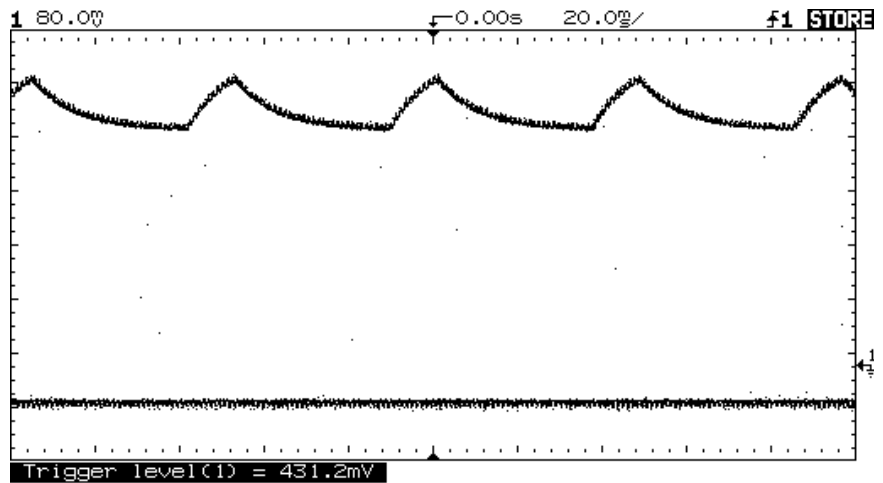
Notice that STORE is displayed in the status line.

3 Set the Trigger Mode to Normal, then adjust the trigger level into the noise region of the signal.

4 Decrease the sweep speed for better resolution of the asynchronous noise.

- To characterize the asynchronous noise signal, use the cursors.

Figure 2-19



This is a triggered view of the asynchronous noise shown in figure 2-18.

---

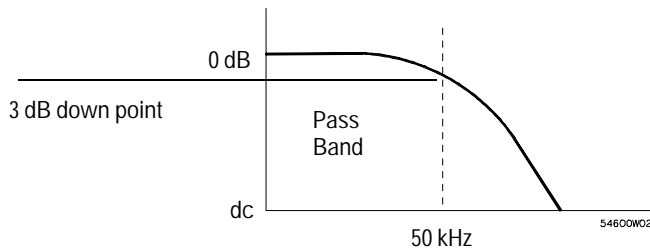
## To reduce the random noise on a signal

If the signal you are applying to the oscilloscope is noisy (figure 2-22), you can set up the oscilloscope to reduce the noise on the waveform (figure 2-23). First, you stabilize the displayed waveform by removing the noise from the trigger path. Second, you reduce the noise on the displayed waveform.

- 1 Connect a signal to the oscilloscope and obtain a stable display.
- 2 Remove the noise from the trigger path by turning on either high frequency reject or noise reject.

High frequency reject (HF Reject) adds a low pass filter with the 3 dB point at 50 kHz (see figure 2-20). You use HF reject to remove high

Figure 2-20



frequency noise such as AM or FM broadcast stations from the trigger path.

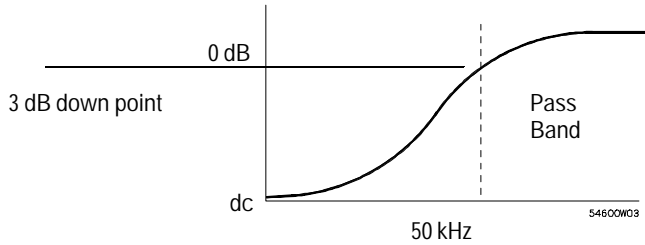
**HF reject**

## Operating Your Oscilloscope

### To reduce the random noise on a signal

Low frequency reject (LF Reject) adds a high pass filter with the 3-dB point at 50 kHz (see figure 2-21). Use LF reject to remove low frequency signals such as power line noise from the trigger path.

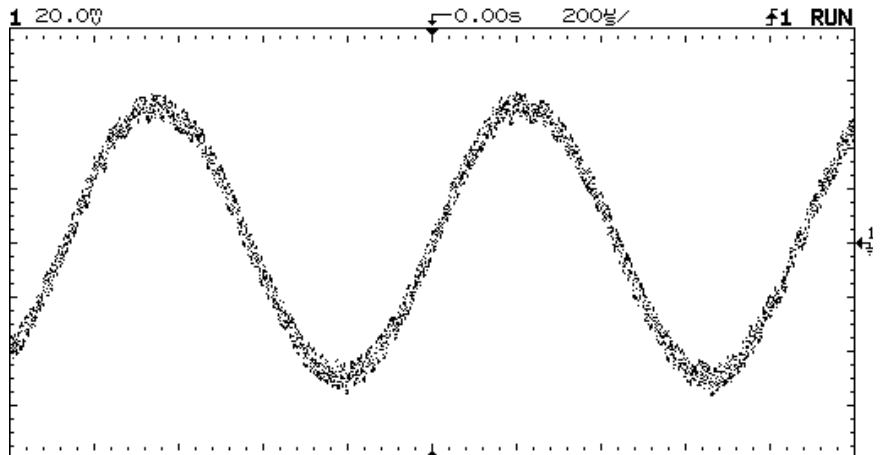
Figure 2-21



### LF reject

Noise reject increases the trigger hysteresis band. By increasing the trigger hysteresis band you reduce the possibility of triggering on noise. However, this also decreases the trigger sensitivity so that a slightly larger signal is required to trigger the oscilloscope.

Figure 2-22



Random noise on the displayed waveform

**3 Use averaging to reduce noise on the displayed waveform.**

To use averaging follow these steps.

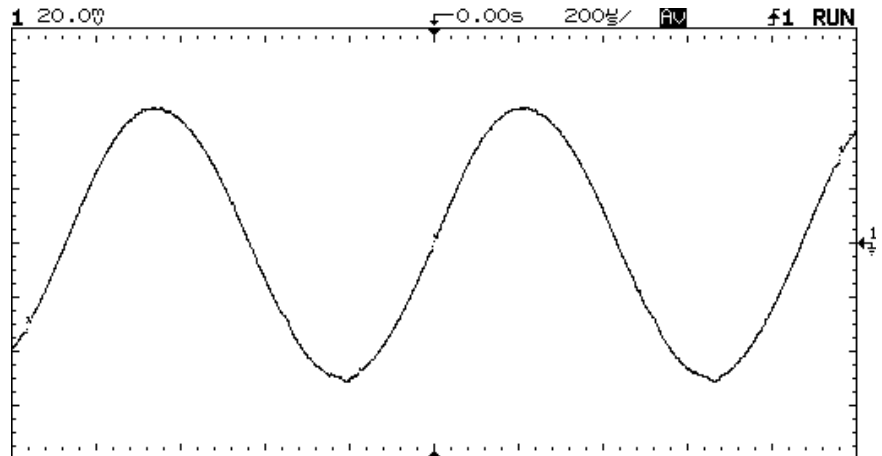
- Press `Display`, then press the `Average` softkey.

Notice that `Av` appears in the status line.

- Toggle the `# Average` softkey to select the number of averages that best eliminates the noise from the displayed waveform.

The `Av` letters in the status line indicate how much of the averaging process is finished by turning to inverse video as the oscilloscope performs averaging. The higher the number of averages, the more noise that is removed from the display. However, the higher the number of averages, the slower the displayed waveform responds to waveform changes. You need to choose between how quickly the waveform responds to changes and how much noise there is on the signal.

Figure 2-23



On this waveform, 256 averages were used to reduce the noise

## To analyze video waveforms

The TV sync separator in the oscilloscope has an internal clamp circuit. This removes the need for external clamping when you are viewing unclamped video signals. TV triggering requires two vertical divisions of display, either channel 1 or channel 2 as the trigger source, and the selection of internal trigger. Turning the trigger level knob in TV trigger does not change the trigger level because the trigger level is automatically set to the sync pulse tips.

For this exercise connect the oscilloscope to the video output terminals on a television. Then set up the oscilloscope to trigger on the start of Frame 2. Use the delayed sweep to window in on the vertical interval test signals (VITS), which are in Line 18 for most video standards (NTSC, PAL, SECAM).

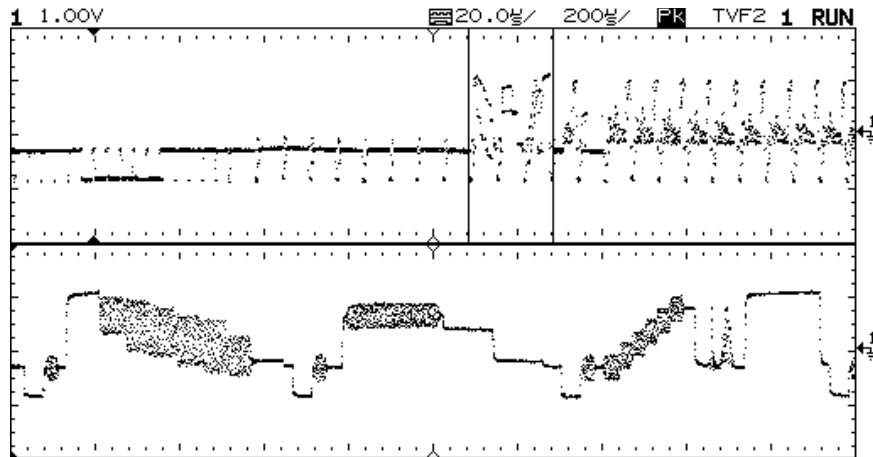
- 1 Connect a TV signal to channel 1, then press `Autoscale`.
- 2 Press `Display`, then press the `Peak Det` softkey.
- 3 Press `Mode`, then press the `TV` softkey.
- 4 Press `Slope/Coupling`, then press the `Field 2` softkey.



Polarity Selects either positive or negative sync pulses.  
Field 1 Triggers on the field 1 portion of the video signal.  
Field 2 Triggers on the field 2 portion of the video signal.  
Line Triggers on all the TV line sync pulses.  
HF Rej Controls a 500 kHz low pass filter in the trigger path.

- 5 Set the time base to  $200\ \mu\text{s}/\text{div}$ , then center the signal on the display with the delay knob (delay about  $800\ \mu\text{s}$ ).
- 6 Press  , then press the Delayed softkey.
- 7 Set the delayed sweep to  $20\ \mu\text{s}/\text{div}$ , then set the expanded portion over the VITS (delay about  $988.8\ \mu\text{s}$ ).

Figure 2-24

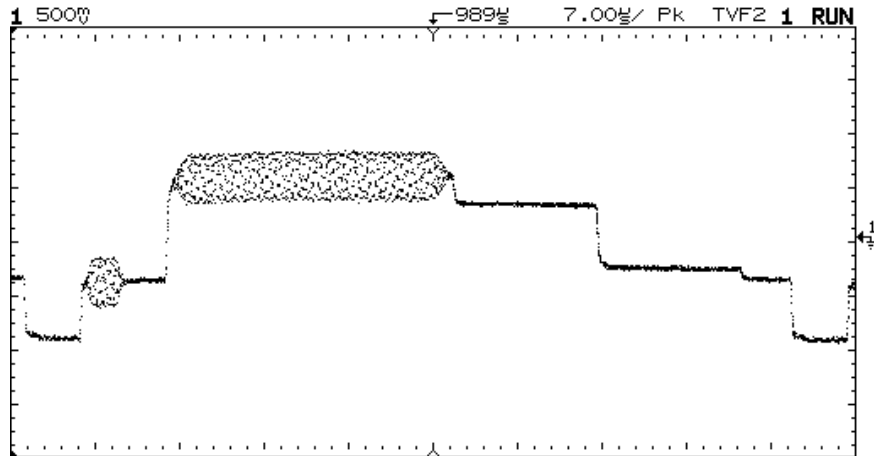


Frame 2 windowed on the VITS in Line 18

Operating Your Oscilloscope  
To analyze video waveforms

- 8 Press  , then press the Main softkey.
- 9 Use the horizontal vernier to change the time base to  $7\ \mu\text{s}/\text{div}$ , then center the signal on the display with the delay knob (delay about  $989\ \mu\text{s}$ ).

Figure 2-25



Full screen display of the IRE

### Delay in TV line units hint

The HP 54610 oscilloscope has the ability to display delay in TV-line units. Using the TV field trigger mode activates this line-counting feature. When Field 1 or Field 2 is selected as the trigger source, delay can be set in terms of time or line number.

### Both-fields triggering in the HP 54610 hint

The HP 54610 can trigger on the vertical sync pulse in both TV fields at the same time. This allows you to view noninterlaced video signals which are common in computer monitors. To trigger on both sync pulses, press Field 1 and Field 2 at the same time.

### TV trigger operating hints

The color burst changes phase between odd (Fields 1 and 3) and even (Fields 2 and 4). It looks double-triggered. Increase the holdoff to greater than the frame width to finetune your trigger stability. For example, use a holdoff value of around 63 ms for NTSC, and around 76 ms for PAL.

When looking at live video (usually a field), use peak detect to improve the appearance of the display.

When making cursor measurements, use Autostore since you are usually looking for pulse flatness and extremes.

When using line trigger, use minimum holdoff to display all the lines. Due to the relationship between the horizontal and vertical sync frequencies the display looks like it is untriggered, but it is very useful for TV waveform analysis and adjustment because all of the lines are displayed.

## To save or recall traces

The oscilloscope has two pixel memories for storing waveforms. The following exercise guides you through how to store and recall waveforms from pixel memories.

**1 Connect a signal to the oscilloscope and obtain a stable display.**

**2 Press** Trace **.**

A softkey menu appears with five softkey selections. Four of the softkeys are trace memory functions.

**Trace** Selects memory 1 or memory 2.

**Trace Mem** Turns on or off the selected memory.

**Save to** Saves the waveform to the selected memory. The front-panel setup is saved to a separate memory location.

**Clear** Erases the selected memory.

**Recall Setup** Recalls the front-panel setup that was saved with the waveform.

**3 Toggle the Trace softkey to select memory 1 or memory 2.**

**4 Press the Save to softkey.**

The current display is copied to the selected memory.

**5 Turn on the Trace Mem softkey to view the stored waveform.**

The trace is copied from the selected trace memory and is displayed in half bright video.

The automatic measurement functions do not operate on stored traces. Remember, the stored waveforms are pictorial information rather than stored data.

- If you have not changed the oscilloscope setup, use the cursors to make the measurements.
- If you have changed the oscilloscope setup, press the **Recall Setup** softkey. Then, use the cursors to make the measurements.

#### Trace memory operating hint

The standard oscilloscope has volatile trace memories. When you add an interface module to the oscilloscope, the trace memories become nonvolatile.

---

## To save or recall front-panel setups

There are 16 memories for storing front-panel setups. Saving front-panel setups can save you time in situations where several setups are repeated many times.

- 1** Press **Setup**.
- 2** To change the selected memory location, press either the left-most softkey or turn the knob closest to the **Cursors** key.
- 3** Press the **Save** softkey to save a front-panel setup, then press the **Recall** softkey to recall a front-panel setup.

---

## To use the XY display mode

The XY display mode converts the oscilloscope from a volts versus time display to a volts versus volts display. You can use various transducers so the display could show strain versus displacement, flow versus pressure, volts versus current, or voltage versus frequency. This exercise shows a common use of the XY display mode by measuring the phase shift between two signals of the same frequency with the Lissajous method.

- 1 Connect a signal to channel 1, and a signal of the same frequency but out of phase to channel 2.
- 2 Press `Autoscale` , press `Main/Delayed` , then press the XY softkey.
- 3 Center the signal on the display with the Position knobs, and use the Volts/Div knobs and the vertical Vernier softkeys to expand the signal for convenient viewing.

$$\sin \theta = \frac{A}{B} \text{ or } \frac{C}{D}$$

Figure 2-26

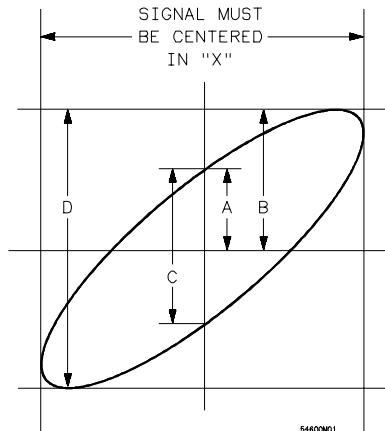
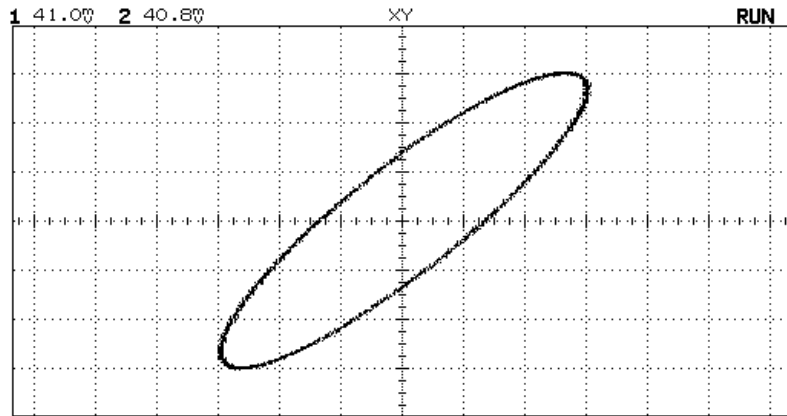


Figure 2-27

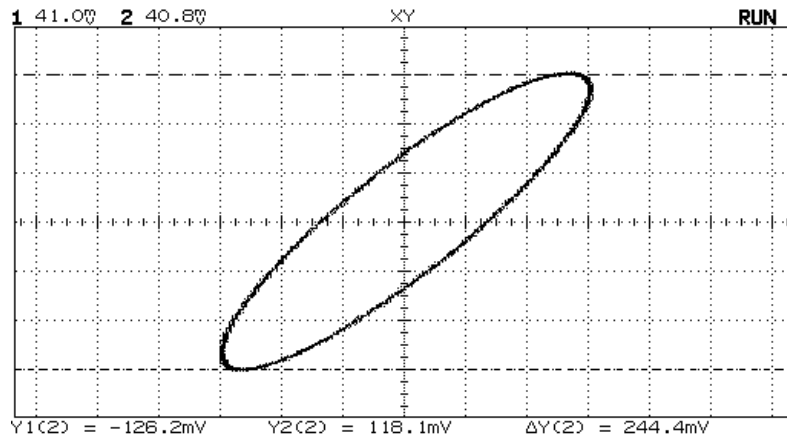


4 Press  .

5 Set the Y2 cursor to the top of the signal, and set Y1 to the bottom of the signal.

Note the  $\Delta Y$  value at the bottom of the display. In this example we are using the Y cursors, but you could have used the X cursors instead. If you use the X cursors, make sure you center the signal in the Y axis.

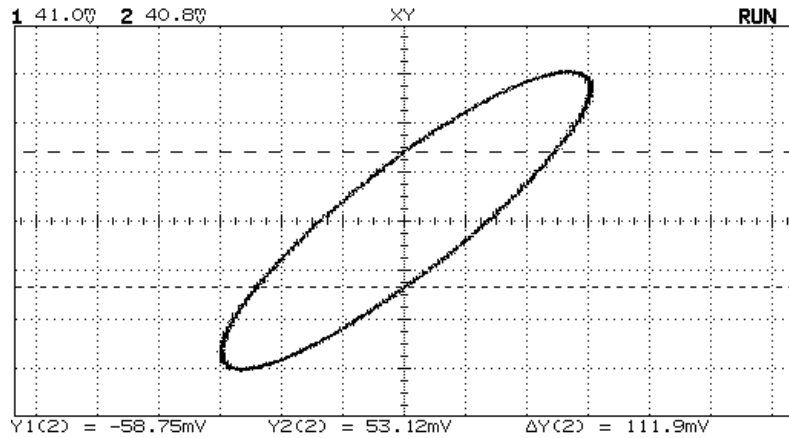
Figure 2-28



Operating Your Oscilloscope  
To use the XY display mode

- 6 Move the Y1 and Y2 cursors to the center of the signal.  
Again, note the  $\Delta Y$  value.

Figure 2-29

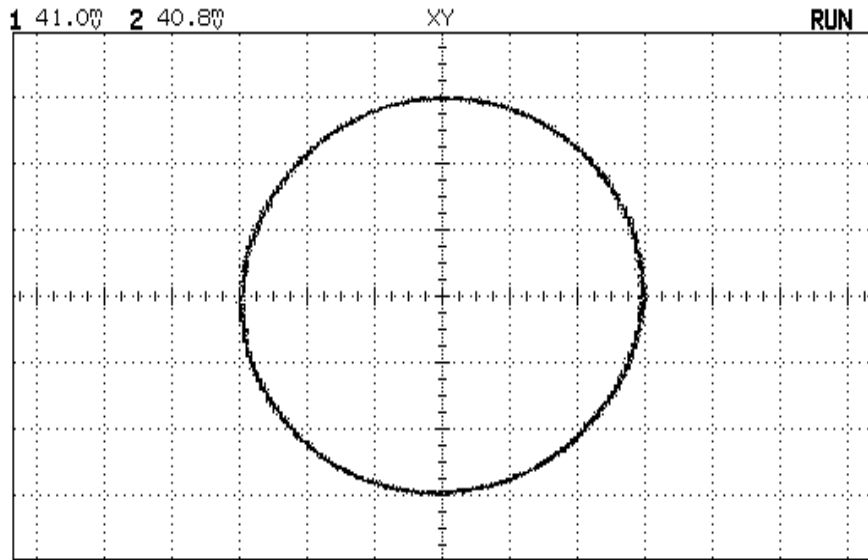


- 7 Calculate the phase difference using formula below.

$$\sin \theta = \frac{\text{second } \Delta Y}{\text{first } \Delta Y} = \frac{111.9}{244.4} = 27.25 \text{ degrees of phase shift.}$$

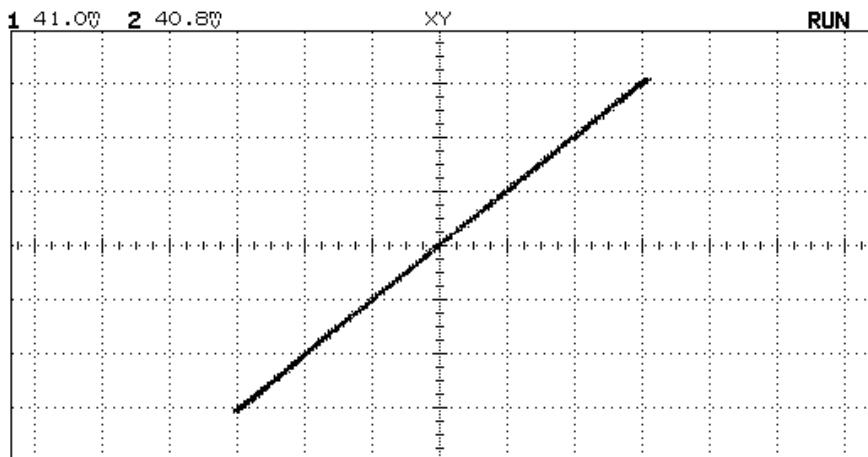


Figure 2-30



Signals are 90° out of phase

Figure 2-31



Signals are in phase

Operating Your Oscilloscope  
**To use the XY display mode**

**XY display mode operating hint**

When you select the XY display mode, the time base is turned off. Channel 1 is the X-axis input, channel 2 is the Y-axis input, and the external trigger in the HP 54610 is the Z-axis input. If you only want to see portions of the Y versus X display, use the Z-axis input. Z-axis turns on and off the trace (analog oscilloscopes called this Z-blanking because it turned the beam on and off). When Z is low (<1.3 V), Y versus X is displayed; when Z is high (>1.3 V), the trace is turned off.

Verifying Oscilloscope Performance 3-5  
Adjusting the Oscilloscope 3-21  
Troubleshooting the Oscilloscope 3-30  
Replacing Parts in the Oscilloscope 3-39

---

# Service

If the oscilloscope is under warranty, you must return it to Hewlett-Packard for all service work covered by the warranty. See "To return the oscilloscope to Hewlett-Packard," on page 3-4. If the warranty period has expired, you can still return the oscilloscope to Hewlett-Packard for all service work. Contact your nearest Hewlett-Packard Sales Office for additional details on service work.

If the warranty period has expired and you decide to service the oscilloscope yourself, the instructions in this chapter can help you keep the oscilloscope operating at optimum performance.

This chapter is divided into the following four sections:

- Verifying Oscilloscope Performance on page 3-5
- Adjusting the Oscilloscope on page 3-21
- Troubleshooting the Oscilloscope on page 3-30
- Replacing Parts in the Oscilloscope on page 3-39. Service should be performed by trained service personnel only. Some knowledge of the operating controls is helpful, and you may find it helpful to read chapter 1, "The Oscilloscope at a Glance."

Table 3-1

---

**Recommended list of test equipment to service the oscilloscope**


---

| <b>Equipment</b>                | <b>Critical specifications</b>                    | <b>Recommended Model/Part</b>       | <b>Use<sup>1</sup></b> |
|---------------------------------|---|-------------------------------------|------------------------|
| Signal generator                | 1 to 500 MHz at 200 mV<br>high stability timebase | HP 8656B Option 001                 | P                      |
| Digital multimeter              | 0.1 mV resolution, better than 0.01%<br>accuracy  | HP 34401A                           | P, A, T                |
| Oscilloscope                    | 100 MHz   | HP 54600A                           | T                      |
| Power meter and<br>Power sensor | 1 to 500 MHz $\pm$ 3% accuracy                    | HP 436A and HP 8482A                | P                      |
| Power supply                    | 14 mV to 35 Vdc, 0.1 mV resolution                | HP 6114A                            | P                      |
| Pulse generator                 | Rise time < 175 ps                                | PSPL 1107B TD and PSPL 1110B Driver | A                      |
| Pulse generator                 | 10 kHz, 500 mV p-p, rise time <5 ns               | HP 8112A                            | A                      |
| Power splitter                  | Outputs differ < 0.15 dB                          | HP 11667B                           | P                      |
| Shorting cap                    | BNC   | HP 1250-0774                        | P                      |
| Time Mark Generator             | Stability 5 ppm after 30 minutes                  | Tektronix TG501A and TM503B         | P                      |
| Adapter                         | SMA (f) to BNC (m)                                | HP 1250-1787                        | A                      |
| Adapter                         | BNC (f-f)   | HP 1250-0080                        | P, A                   |
| Adapter                         | BNC tee (m) (f) (f)                               | HP 1250-0781                        | P, A                   |
| Adapter                         | N (m) to BNC (f), Qty 3                           | HP 1250-0780                        | P                      |
| Adapter                         | BNC (f) to dual banana (m)                        | HP 1251-2277                        | P                      |
| Adapter                         | Type N (m) to BNC (m)                             | HP 1251-0082                        | P                      |
| Cable                           | BNC, Qty 3  | HP 10503A                           | P, A                   |
| Cable                           | BNC, 9 inches, Qty 2                              | HP 10502A                           | P, A                   |
| Cable                           | Type N (m) 24 inch                                | HP 11500B                           | P                      |

P = Use for Performance Verification.

A = Use for Adjustments.

T = Use for Troubleshooting.

## To return the oscilloscope to Hewlett-Packard

Before shipping the oscilloscope to Hewlett-Packard, contact your nearest Hewlett-Packard Sales Office for additional details.

**1 Write the following information on a tag and attach it to the oscilloscope.**

- Name and address of owner
- Model number
- Serial number
- Description of service required or failure indications

**2 Remove all accessories from the oscilloscope.**

The accessories include the power cord, probes, cables, and any modules attached to the rear of the oscilloscope. Do not ship accessories back to Hewlett-Packard unless they are associated with the failure symptoms.

**3 Protect the control panel with cardboard.**

**4 Pack the oscilloscope in styrofoam or other shock-absorbing material and place it in a strong shipping container.**

You can use either the original shipping containers, or order materials from an HP Sales Office. Otherwise, pack the oscilloscope in 3 to 4 inches of shock-absorbing material to prevent movement inside the shipping container.

**5 Seal the shipping container securely.**

**6 Mark the shipping container as FRAGILE.**

---

# Verifying Oscilloscope Performance

This section shows you how to verify the electrical performance of the oscilloscope, using the performance characteristics in chapter 4 as the standard. The characteristics checked are dc calibrator, voltage measurement accuracy, bandwidth, horizontal accuracy, and trigger sensitivity.

You should verify the performance of the oscilloscope when you first receive it, and every 12 months or after 2,000 hours of operation. Also, make sure you allow the oscilloscope to operate for at least 30 minutes before you begin the following procedures.

### **Perform self-calibration first**

For the oscilloscope to meet all of the verifications tests in the ambient temperature where it will be used, the self-calibration tests described on page 3-24 should first be performed. Allow the unit to operate for at least 30 minutes before performing the self-calibration.

Each procedure lists the recommended equipment for the test. You can use any equipment that meets the critical specifications. However, the procedures are based on the recommended model or part number.

On page 3-20 of this chapter is a test record for recording the test results of each procedure. Use the test results to gauge the performance of the oscilloscope over time.

---

## To check the output of the DC CALIBRATOR

In this test you measure the output of the DC CALIBRATOR with a multimeter. The DC CALIBRATOR is used for self-calibration of the oscilloscope. The accuracy is not specified, but it must be within the test limits to provide for accurate self-calibration.

Test limits: 5.000 V  $\pm$ 10 mV and 0.000 V  $\pm$  500  $\mu$ V.

Table 3-2

---

### Equipment Required

---

| Equipment          | Critical specifications                        | Recommended Model/Part |
|--------------------|--|------------------------|
| Digital Multimeter | 0.1% mV revolution, better than 0.01% accuracy | HP 34401A              |
| Cable              | BNC  | HP 10503A              |

**1** Connect a multimeter to the rear panel DC CALIBRATOR connector.

**2** Press .

**3** Press the **Self Test** softkey, then press the **DAC** softkey.

The multimeter should measure 0.00 V dc  $\pm$  500  $\mu$ V. If the result is not within the test limits, see "Troubleshooting the oscilloscope," on page 3-30.

**4** Press any key to continue the test.

The multimeter should read 5.000 V  $\pm$ 10 mV. If the result is not within the test limits, see "Troubleshooting the oscilloscope," on page 3-30.



---

## To verify voltage measurement accuracy

In this test you verify the voltage measurement accuracy by measuring the output of a power supply using dual cursors on the oscilloscope, and comparing the results with a multimeter.

Test limits:  $\pm 2\%$  of reading  $\pm 0.4\%$  of full scale.

**Table 3-3**

---

### Equipment Required

| Equipment          | Critical specifications            | Recommended Model/Part |
|--------------------|------------------------------------|------------------------|
| Power supply       | 14 mV to 35 Vdc, 0.1 mV resolution | HP 6114A               |
| Digital multimeter | Better than 0.1% accuracy          | HP 34401A              |
| Cable              | BNC, Qty 2                         | HP 10503A              |
| Shorting cap       | BNC                                | HP 1250-0774           |
| Adapter            | BNC (f) to banana (m)              | HP 1251-2277           |
| Adapter            | BNC tee (m) (f) (f)                | HP 1250-0781           |

Service  
**Verifying Oscilloscope Performance**

- 1 Set up the oscilloscope.**
  - a** Press **Setup** , then press the Default Setup softkey.
  - b** Press **Voltage** , then press the Vavg softkey.
  - c** Set the Volts/Div to the first line of table 3-4.
  - d** Adjust the channel 1 Position knob to place the baseline near (but not at) the bottom of the display.
- 2** Press **Cursors** , then press the V1 softkey.
- 3** Using the cursors knob, set the V1 cursor on the baseline.

If you are in an electrically noisy environment, it can help to place a shorting cap on the input BNC connector when positioning V1.
- 4** Connect the power supply to the oscilloscope and to the multimeter, using the BNC tee and cables.
- 5** Set the power supply output to the first line in table 3-4.

- 6** Press the V2 softkey, then position the V2 cursor to the baseline.  
 The  $\Delta V$  value at the bottom of the display should be within the test limits of table 3-4. If a result is not within the test limits, see "Troubleshooting the Oscilloscope," on page 30.
- 7** Continue checking the voltage measurement accuracy with the remaining lines in table 3-4.

**Table 3-4**

| <b>Equipment Required</b> |                             |                    |    |           |
|---------------------------|-----------------------------|--------------------|----|-----------|
| <b>Volts/Div setting</b>  | <b>Power supply setting</b> | <b>Test limits</b> |    |           |
| 5 V/Div                   | 35 V                        | 34.14 V            | to | 35.86 V   |
| 2 V/Div                   | 14 V                        | 13.656 V           | to | 14.344 V  |
| 1 V/Div                   | 7 V                         | 6.828 V            | to | 7.172 V   |
| 0.5 V/Div                 | 3.5 V                       | 3.414 V            | to | 3.586 V   |
| 0.2 V/Div                 | 1.4 V                       | 1.3656 V           | to | 1.4344 V  |
| 0.1 V/Div                 | 700 mV                      | 682.8 mV           | to | 717.2 mV  |
| 50 mV/Div                 | 350 mV                      | 341.4 mV           | to | 358.6 mV  |
| 20 mV/Div                 | 140 mV                      | 136.56 mV          | to | 143.44 mV |
| 10 mV/Div                 | 70 mV                       | 68.28 mV           | to | 71.72 mV  |
| 5 mV/Div*                 | 35 mV                       | 33.98 mV           | to | 36.02 mV  |
| 2 mV/Div*                 | 14 mV                       | 13.4 mV            | to | 14.6 mV   |

- 8** Disconnect the power supply from the oscilloscope, then repeat steps 1 to 7 for channel 2.

\*Full scale is defined as 80 mV on the 5 mV/div and 2 mV/div ranges.

---

## To verify bandwidth

In this test you verify bandwidth by using a power meter and power sensor to set output of a signal generator at 1 MHz and the upper bandwidth limit. You use the peak-to-peak voltage at 1 MHz and the upper bandwidth limit to calculate the bandwidth response of the oscilloscope.

Test limits:

HP 54610, all channels (-3 dB)  
dc to 500 MHz  
ac coupled 10 Hz to 500 MHz.

**Table 3-5**

---

### Equipment Required

| <b>Equipment</b>                | <b>Critical specifications</b>  | <b>Recommended Model/Part</b> |
|---------------------------------|---------------------------------|-------------------------------|
| Signal generator                | 1 to 500 MHz at 200 mV          | HP 8656B opt 001              |
| Power meter and<br>Power Sensor | 1 to 500 MHz $\pm 3\%$ accuracy | HP 436A and HP 8482A          |
| Power splitter                  | Outputs differ by $< 0.15$ dB   | HP 11667B                     |
| Cable                           | Type N (m), 24 inch             | HP 11500B                     |
| Adapter                         | Type N (m) to BNC (m)           | HP 1251-0082                  |

- 1** Connect the equipment.
  - a** Connect the signal generator to the input of the power splitter.
  - b** Connect the power sensor to one output of the power splitter, and connect channel 1 of the oscilloscope to the other power splitter output. Set the oscilloscope input impedance to  $50\Omega$ .
- 2** Set up the oscilloscope.
  - a** Press `Setup` , then press the `Default Setup` softkey.
  - b** Set the time base to 500 ns/div.
  - c** Press 1 to select channel 1, then select  $50\Omega$  input and 100 mV/div.
  - d** Press `Display` , then press the `Average` softkey.
  - e** Toggle the # `Average` softkey to select 8 averages.
- 3** Set the signal generator for 1 MHz at about 5.6 dBm.

Notice that the signal on the display is about 5 cycles and six divisions of amplitude.

## Verifying Oscilloscope Performance

- 4** Press voltage, then press the  $V_{p-p}$  softkey.

Wait a few seconds for the measurement to settle (averaging is complete), then note the  $V_{p-p}$  reading from the bottom of the display.

$V_{p-p} = \underline{\hspace{2cm}}$  mV.

- 5** Set the calibration factor percent of the power meter to the 1 MHz value from the calibration chart on the probe, then press dB (REF) on the power meter to set a 0 dB reference.

- 6** Change the frequency of the signal generator to 500 MHz

- 7** Set the calibration factor of the power meter to 500 MHz percent value from the chart on the probe.

Adjust the amplitude of the signal generator for a power reading as close as possible to 0.0 dB (REL). Power meter reading =  $\underline{\hspace{2cm}}$  dB.

**8** Change the time base to 5 ns/div.

Wait a few seconds for the measurement to settle (averaging is complete), then note the Vp-p reading from the bottom of the display.

Vp-p = \_\_\_\_\_ mV.

**9** Calculate the response using the following formula.

$$20 \log_{10} \left( \frac{\text{step 8 result}}{\text{step 4 result}} \right)$$

**10** Correct the result from step 9 with any difference in the power meter reading from step 7. Make sure you observe all number signs.

For example:

Result from step 9 = -2.3 dB

Power meter reading from step 7 = -0.2 dB (REL)

True response = (-2.3) - (-0.2) = -2.1 dB

The true response should be  $\leq -3$  dB.

If the result is not  $\leq -3$  dB, see "Troubleshooting the Oscilloscope," on page 3-30.

**11** Repeat steps 1 to 10 for channel 2.

---

## To verify horizontal $\Delta t$ and $1/\Delta t$ accuracy

In this test you verify the horizontal  $\Delta t$  and  $1/\Delta t$  accuracy by measuring the output of a time mark generator with the oscilloscope.

Test limits:  $\pm 0.01\%$   $\pm 0.2\%$  of full scale  $\pm 100$  ps (same channel)

Table 3-6

---

### Equipment Required

| Equipment             | Critical specifications        | Recommended Model/Part |
|-----------------------|--------------------------------|------------------------|
| Time marker generator | Stability 5 ppm after 1/2 hour | TG 501A and TM 503B    |
| Cable                 | BNC, 3 feet                    | HP 10503A              |

- 1** Connect the time mark generator to channel 1. Then, set the time mark generator for 0.1 ms markers.
- 2** Setup the oscilloscope.
  - a** Press  , then press the Default Setup softkey.
  - b** Press  .
  - c** Set the time base to 20  $\mu$ s/div.
  - d** Adjust the trigger level to obtain a stable display.



- 3** Press Time, then press the **Freq** and **Period** softkeys.

You should measure the following:

Frequency 10 kHz, test limits are 9.899 kHz to 10.10 kHz.

Period 100  $\mu$ s, test limits are 98.98  $\mu$ s to 101.01  $\mu$ s.

If the measurements are not within the test limits, see "Troubleshooting the Oscilloscope," on page 3-30.

- 4** Change the time mark generator to 1  $\mu$ s, and change the time base to 200 ns/div. Adjust the trigger level to obtain a stable display.

- 5** Press Time, then press the **Freq** and **Period** softkeys.

You should measure the following:

Frequency 1 MHz, test limits are 989.8 kHz to 1.0104 MHz.

Period 1  $\mu$ s, test limits are 989.7 ns to 1.010  $\mu$ s.

If the measurements are not within the test limits, see "Troubleshooting the Oscilloscope," on page 3-30.

- 6** Change the time mark generator to 20 ns, and change the time base to 5 ns/div. Adjust the trigger level to obtain a stable display.

- 7** Press Time, then press the **Freq** and **Period** softkeys.

You should measure the following:

Frequency 50 MHz, test limits are 48.43 MHz to 51.68 MHz.

Period 20 ns, test limits are 19.35 ns to 20.65 ns.

If the measurements are not within the test limits, see "Troubleshooting the Oscilloscope," on page 3-30.

## Verifying Oscilloscope Performance

- 8** Change the time mark generator to 2 ns, and change the time base to 1 ns/div. Adjust the trigger level to obtain a stable display.
- 9** Press  , then press the Freq and Period softkeys.

You should measure the following:

Frequency 500 MHz, test limits are 475.29 MHz to 527.426 MHz.

Period 2 ns, test limits are 1.896 ns to 2.104 ns.

If the measurements are not within the test limits, see "Troubleshooting the Oscilloscope," on page 3-30.

## To verify trigger sensitivity

In this test you verify the trigger sensitivity by applying 25 MHz to the oscilloscope. The amplitude of the signal is decreased to the specified levels, then you check to see if the oscilloscope is still triggered. You then repeat the process at the upper bandwidth limit.

Test limits:

Internal trigger

dc to 25 MHz, 0.35 div or 3.5 mV p-p

dc to 500 MHz, 1 div or 10 mV p-p

External trigger

dc to 25 MHz, 50 mV p-p

dc to 500 MHz, > 100 mV p-p

Table 3-7

### Equipment Required

| Equipment                    | Critical specifications       | Recommended Model/Part |
|------------------------------|-------------------------------|------------------------|
| Signal generator             | 25 MHz and 500 MHz sine waves | HP 8656B Option 001    |
| Power splitter               | Outputs differ < 0.15 dB      | HP 11667B              |
| Cable                        | BNC, Qty 3                    | HP 10503A              |
| Adapter                      | N (m) to BNC (f), Qty 3       | HP 1250-0780           |
| Power meter and Power sensor | 1 to 500 MHz +/-3%            | HP 436A and HP 8482A   |

Service  
**Verifying Oscilloscope Performance**

Internal Trig  
Sensitivity

- 1** Press  , then press the Default Setup softkey.
- 2** Connect the signal generator to channel 1.
- 3** Verify the trigger sensitivity at 25 MHz and 0.35 divisions.
  - a** Set the signal generator to 25 MHz and about 50 mV.
  - b** Press  .
  - c** Press 1 to select channel 1, then select 50 $\Omega$  input impedance.
  - d** Decrease the output of the signal generator until there is 0.35 vertical divisions of the signal displayed.

The trigger should be stable. If the triggering is not stable, try adjusting the trigger level. If adjusting the trigger level makes the triggering stable, the test still passes. If adjusting the trigger does not help, see "Troubleshooting the Oscilloscope," on page 3-30.
- 4** Verify the trigger sensitivity at 1 division for the frequency shown below.
  - a** Change the output of the signal generator to 500 MHz and set amplitude to about 100 mV.
  - b** Press  .
  - c** Decrease the output of the signal generator until there is 1 vertical division of the signal displayed.

The trigger should be stable. If the triggering is not stable, try adjusting the trigger level. If adjusting the trigger level makes the triggering stable, the test still passes. If adjusting the trigger does not help, see "Troubleshooting the Oscilloscope," on page 3-30.
- 5** Repeat steps 1 through 4 for channel 2.

External Trig  
Sensitivity

- 6** Verify the external trigger sensitivity at 500 MHz at 100 mV p-p, and at 25 MHz at 50 mV p-p.
  - a** Press  , then press the Ext softkey.
  - b** Press  , then select external trigger with input coupling of 50 $\Omega$ .
  - c** Press  then select signal input coupling of 50  $\Omega$ .
  - d** Using the power splitter, connect one signal generator output to the channel 1 input and the other signal generator output to the power sensor.
  - e** Set the power meter Cal Factor to the 500 MHz value from the chart on the power sensor.
  - f** Set signal generator frequency to 500 MHz and adjust the output amplitude to achieve a power meter reading of 0.05 mW. (This corresponds to 100 mV p-p.)
  - g** Set Time/div to 1 ns/div.
  - h** Disconnect power meter from divider and connect divider output to External Trigger Input.
  - i** Check for stable triggering, adjusting trigger level if necessary.
  - j** Change the signal generator frequency to 25 MHz at output amplitude of 50 mV p-p, as measured with the HP 54610. Press `Voltage`, then the softkey `Vp-p`.
  - k** Set Time/div to 10 ns/div.
  - l** Check for stable triggering, adjusting trigger level if necessary.
  - m** Record results in Performance Test Record. If test fails, refer to "Troubleshooting the Oscilloscope" on page 3-30.



Serial No. \_\_\_\_\_

Test by \_\_\_\_\_

Test Interval \_\_\_\_\_

Work Order No. \_\_\_\_\_

Recommended Next Testing \_\_\_\_\_

Temperature \_\_\_\_\_

**Output of dc calibrator**

**Limits**

4.990 V to 5.010 V

**Result**

\_\_\_\_\_

**Voltage measurement accuracy**

**Range**

**Reading**

**Test Limits**

**Channel 1**

**Channel 2**

5 V/Div

35 V

34.14 V to 35.86 V

\_\_\_\_\_

\_\_\_\_\_

2 V/Div

14 V

13.656 V to 14.344 V

\_\_\_\_\_

\_\_\_\_\_

1 V/Div

7 V

6.828 V to 7.172 V

\_\_\_\_\_

\_\_\_\_\_

500 mV/Div

3.5 V

3.414 V to 3.586 V

\_\_\_\_\_

\_\_\_\_\_

200 mV/Div

1.4 V

1.3656 V to 1.4344 V

\_\_\_\_\_

\_\_\_\_\_

100 mV/Div

700 mV

682.8 mV to 717.2 mV

\_\_\_\_\_

\_\_\_\_\_

50 mV/Div

350 mV

341.4 mV to 358.6 mV

\_\_\_\_\_

\_\_\_\_\_

20 mV/Div

140 mV

136.56 mV to 143.44 mV

\_\_\_\_\_

\_\_\_\_\_

10 mV/Div

70 mV

68.28 mV to 71.72 mV

\_\_\_\_\_

\_\_\_\_\_

5 mV/Div

35 mV

33.98 mV to 36.02 mV

\_\_\_\_\_

\_\_\_\_\_

2 mV/Div

14 mV

13.4 mV to 14.6 mV

\_\_\_\_\_

\_\_\_\_\_

**Bandwidth**

**Test Limits**

**Channel 1**

**Channel 2**

≤-3 dB

\_\_\_\_\_

\_\_\_\_\_

**Horizontal Δt and 1/Δt accuracy**

**Reading**

**Test Limits**

**Results**

Frequency

10 kHz

9.899 kHz to 10.10 kHz

\_\_\_\_\_

Period

100 μs

98.98 μs to 101.01 μs

\_\_\_\_\_

Frequency

1 MHz

989.8 kHz to 1.0104 MHz

\_\_\_\_\_

Period

1 μs

989.7 ns to 1.010 μs

\_\_\_\_\_

Frequency

50 MHz

48.43 MHz to 51.68 MHz

\_\_\_\_\_

Period

20 ns

19.35 ns to 20.65 ns

\_\_\_\_\_

Frequency

50 MHz

475.29 MHz to 527.426 MHz

\_\_\_\_\_

Period

2 ns

1.896 ns to 2.104 ns

\_\_\_\_\_

**Trigger sensitivity**

**Test Limits**

**Channel 1**

**Channel 2**

Internal trigger

25 MHz at 0.35 divisions

\_\_\_\_\_

\_\_\_\_\_

500 MHz at 1 division

\_\_\_\_\_

\_\_\_\_\_

**External**

External trigger

500 MHz at 100 mV p-p

\_\_\_\_\_

25 MHz at 50 mV p-p

\_\_\_\_\_

---

## Adjusting the Oscilloscope

This section explains how to adjust the oscilloscope so that it is at optimum operating performance. You should perform the hardware adjustments periodically as indicated below.

- Hardware at 12 months or 2,000 hours of operation
- Firmware at 6 months or 1000 hours of operation, or if ambient temperature is greater than 10 °C from the calibration temperature, or if the user desires to maximize the measurement accuracy

The amount of use, environmental conditions, and your past experience with other instruments can help you to determine if you need a shorter adjustment interval.

Make sure you allow the oscilloscope to warm up for at least 30 minutes before you start the adjustments.

---

### WARNING

The maintenance described in this section is performed with power supplied to the oscilloscope and with the protective covers removed. Only trained service personnel who are aware of the hazards involved should perform the maintenance. Whenever possible, perform the procedures with the power cord removed from the oscilloscope. Read the safety summary at the back of this book before proceeding.

---

### CAUTION

Do not disconnect any cables or remove any assemblies with the power applied to the oscilloscope, or damage to the oscilloscope can occur.

---

## To adjust the power supply

On the power supply there is only one adjustment and that is for the +5.1 V. The other voltages are based on the +5.1 V adjustment. In this procedure you use a multimeter to measure the +5.1 V, and if necessary, you adjust the supply to within tolerance.

**Table 3-8**

---

### Equipment Required

---

| Equipment          | Critical specifications                  | Recommended Model/Part |
|--------------------|--|------------------------|
| Digital multimeter | 0.1 mV resolution, accuracy $\pm 0.05\%$ | HP 34401A              |

- 1** Set up the oscilloscope for the voltage adjustment.
  - a** Turn off the oscilloscope and disconnect power cable.
  - b** Remove the cover from the oscilloscope as described in "To replace an assembly" on page 3-40 of this chapter.
  - c** Place the oscilloscope on its side.
  - d** Connect the negative lead of the digital multimeter to a ground point on the oscilloscope.
  - e** Reconnect power cable.
  - f** Turn on the oscilloscope.



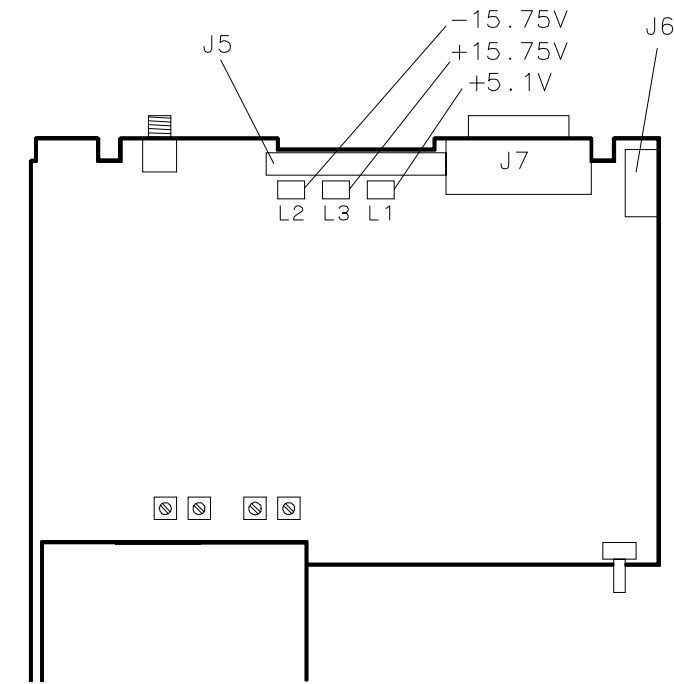
**2 Measure the power supply voltages at L1, L2, and L3 on the system board.**

Make sure that the voltage measurements are within the following tolerances.

|          |                                     |
|----------|-------------------------------------|
| +5.1 V   | $\pm 150$ mV (+4.95 V to +5.25 V)   |
| +15.75 V | $\pm 787$ mV (+14.96 V to +16.54 V) |
| -15.75 V | $\pm 787$ mV (-14.96 V to -16.54 V) |

If the +5.1 V measurement is out of tolerance, adjust the +5.1 V adjustment on the power supply. The  $\pm 15.75$  V supplies are not adjustable and are dependent upon the +5.1 V supply. If adjusting the power supply does not bring all the voltages within tolerance, see "Troubleshooting the Oscilloscope," on page 3-30 in this chapter.

**Figure 3-1**



54600E79

---

## To perform the self-calibration

In this procedure you load the default calibration factors to give a known starting point for the firmware calibration. *However, once the default calibration factors are loaded, you must perform the remainder of the firmware calibration to maintain the accuracy of the oscilloscope.*

**Table 3-9**

---

### Equipment Required

---

| Equipment       | Critical specifications           | Recommended Model/Part |
|-----------------|-----------------------------------|------------------------|
| Pulse generator | 100 kHz, 1 V p-p, rise time <5 ns | HP 8112A               |
| Cable           | BNC, 3 feet                       | HP 10503A              |
| Cable           | BNC, 9 inches, Qty 2              | HP 10502A              |
| Adapter         | BNC tee (m) (f) (f)               | HP 1250-0781           |
| Adapter         | BNC (f-f)                         | HP 1250-0080           |

#### 1 Check the rear panel DC CALIBRATOR output level.

If you are not sure how to check the DC CALIBRATOR, see "To check the output of the DC CALIBRATOR," on page 3-6.

#### 2 Load the default calibration factors.

- a Set the rear-panel CALIBRATION switch to UNPROTECTED (up position).
- b Press Print/Utility, then press the Self Cal Menu softkey.
- c Press the Load Defaults softkey.

Vertical self cal    **3** After the message "Default calibration factors loaded" is displayed on the lower left side of the display, press the  softkey.

**4** Follow the instructions on the display, then press the  softkey.

The display prompts instruct you to connect the rear panel DC CALIBRATOR output first to external trigger, then to channel 1, then to channel 2.

**5** When the message "Press Continue to return to calibration menu" appears on the display, press the  softkey.

Delay self cal

**6** Connect a pulse generator set to 100 kHz and 1 V p-p and with a rise time less than 5 ns to channels 1 and 2. Set the oscilloscope's input impedance to 50Ω. Make sure you use the HP 10502A cables to ensure equal cable lengths.

**7** Press the Delay softkey, then follow the instructions on the display.

The display will instruct you to connect the signal simultaneously to channels 1 and 2, then to channel 1 and external trigger, and finally to channel 2 and external trigger..

**8** Set the rear-panel CALIBRATION switch to PROTECTED.

---

## To adjust the high-frequency pulse response

In this procedure you adjust the high-frequency pulse response for each channel.

**Table 3-10**

---

### Equipment Required

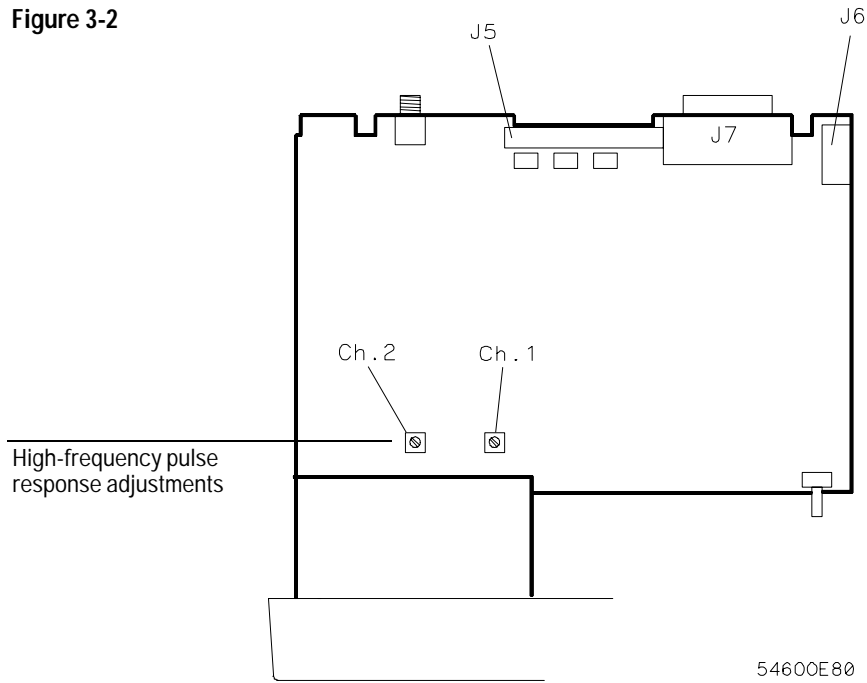
---

| Equipment       | Critical specifications | Recommended Model/Part              |
|-----------------|-------------------------|-------------------------------------|
| Pulse generator | Rise time < 175 ps      | PSPL 1107B TD and PSPL 1110B Driver |
| Adapter         | SMA (f) to BNC (m)      | HP 1250-1787                        |

- 1 Connect the pulse generator to channel 1.
- 2 Press  .
- 3 Change the time base to 10 ns/div.
- 4 Press  , then toggle the Vernier softkey to On.
- 5 Adjust the Volt/Div until there are about 6 divisions of vertical deflection.

- 6 Adjust the channel 1 high-frequency response for 1.5 minor division of overshoot (6%).
- 7 Repeat steps 1 through 6 for channel 2.

Figure 3-2



---

## To adjust the display

The display adjustments are optional and normally do not require adjustment. You should use this procedure only for the few cases when the display is obviously out of adjustment.

**Table 3-11**

---

### Equipment Required

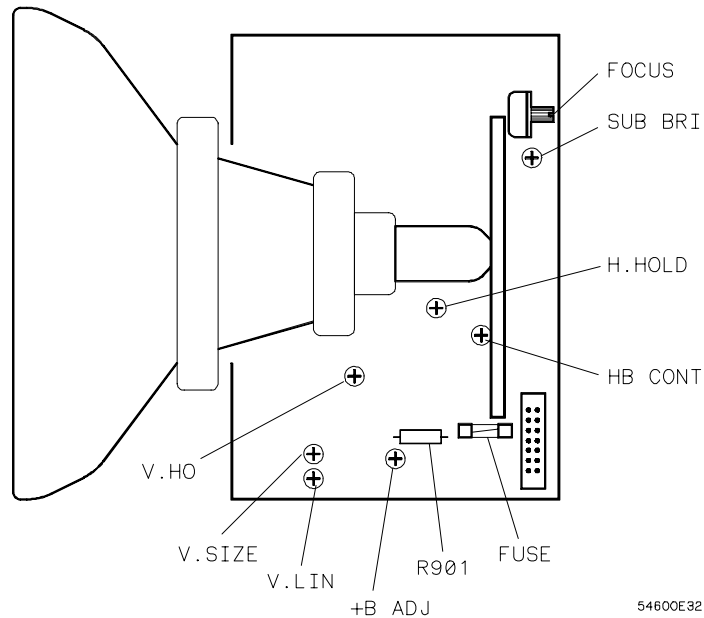
---

| Equipment          | Critical specifications                 | Recommended Model/Part |
|--------------------|---|------------------------|
| Digital multimeter | Accuracy $\pm 0.05\%$ , 1 mV resolution | HP 34401A              |

- 1 Connect the digital multimeter to the end of R901 closest to the fuse. See figure 3-3.
- 2 Adjust +B for +14.00 V.
- 3 Press . Press the Self Test softkey, then press the Display softkey.
- 4 Adjust V.HO (vertical hold) for vertical synchronization.
- 5 Set the intensity control (on the front panel) to mid-range.
- 6 Adjust Sub Bri (sub bright) to the lowest setting so that the half bright blocks on the display are visible.
- 7 Increase the intensity control to a comfortable viewing level.  
This is usually about 3/4 of its maximum range.

- 8 Adjust HB Cont (half bright contrast) for the best contrast between the half bright and full bright blocks.  
You can readjust Sub Bri, intensity control, and HB Cont to suit your individual preference.
- 9 Press any key to continue to the next test pattern. Then, adjust H.Hold (horizontal hold) to center the display horizontally.
- 10 Adjust Focus for the best focus.
- 11 Press any key to continue to the normal display pattern. Then adjust V.Lin (vertical linearity) for equal sizing of all four corner squares.
- 12 Adjust V.Size (vertical size) to center the display vertically at the maximum allowable size without losing the text.  
Adjustments V.Lin and V.Size interact so you may need to readjust sizing and vertical centering of the display.

Figure 3-3



54600E32

---

# Troubleshooting the Oscilloscope

The service policy for this instrument is replacement of defective assemblies. The following procedures can help isolate problems to the defective assembly.

---

**WARNING**

The maintenance described in this section is performed with power supplied to the oscilloscope and with the protective covers removed. Only trained service personnel who are aware of the hazards involved should perform the maintenance. Whenever possible, perform the procedures with the power cord removed from the oscilloscope. Read the safety summary at the back of this book before proceeding.

---

**CAUTION**

Do not disconnect any cables or remove any assemblies with the power applied to the oscilloscope, or damage to the oscilloscope can occur.

The following equipment is needed for troubleshooting the oscilloscope.

**Table 3-12**

---

**Equipment Required**

---

| <b>Equipment</b>        | <b>Critical specifications</b>          | <b>Recommended model/part</b> |
|-------------------------|---|-------------------------------|
| Digital multimeter      | Accuracy $\pm 0.05\%$ , 1 mV resolution | HP 34401A                     |
| Oscilloscope            | 100 MHz                                 | HP 54600A                     |
| Dummy load <sup>1</sup> | Compatible with power supply            | HP 54600-66504                |

<sup>1</sup> See page 3-31 to construct your own dummy load.



## To construct your own dummy load

- 1** Obtain a connector compatible with the connector on the LVPS.
- 2** Connect the following load resistors to the connector.
  - +5.1 V requires a 3 A load, 1.7  $\Omega$  and 15 W on pin 15, 17, or 19.
  - +15.75 V requires a 1.3 A load, 12.2  $\Omega$  and 20.5 W on pin 11 or 13.
  - With the fan operating, -15.75 V requires a 0.6 A load, 26.25  $\Omega$  and 9.5 W on pin 5 or 7.
  - Without the fan operating, -15.75 V requires a 0.8 A load, 26.25  $\Omega$  and 13 W on pin 5 or 7.
- 3** Connect the other end of the resistors to ground pins 2, 4, 6, and 8.

## To check out the oscilloscope

**1 Is there an interface module connected to the oscilloscope?**

If yes, do the following steps. If not, go to step 2.

- a** Turn off the oscilloscope.
- b** Remove the module.
- c** Turn on the oscilloscope, then check for the failing symptom.  
If the failing symptom disappears, replace the module. If not, go to step 2.

**2 Disconnect any external cables from the front panel.**

**3 Disconnect the power cord, then remove the cover.**

**4 Connect the power cord, then turn on the oscilloscope.**

If the display comes on after a few seconds, (HP logo and copyright text, followed by a graticule with text at top of the display) go to "To check the LVPS," on page 3-35. If after checking the LVPS the voltages are within the test limits, go to step 8. If not, go to step 6. If the display did not come on, do the steps below.

- a** Check the intensity knob to see setting to see if its set too low.
- b** If there is still no display, disconnect the power cord.
- c** Check all cable connections.
- d** Go to "To check the LVPS," on page 3-35.

If the voltages are within the limits go to step 5. If not, go to step 6.

- 5 Disconnect the display cable, then check the following signals on the system board.

**Table 3-13**

**Signals at U56**

|            | <b>Signal</b> | <b>Frequency</b> | <b>Pulse width</b> | <b>Voltage</b> |
|------------|---------------|------------------|--------------------|----------------|
| U16 Pin 7  | DE            | 19.72 kHz        | 38.0 $\mu$ s       | 2.6 Vp-p       |
| U16 Pin 24 | Hsync         | 19.72 kHz        | 3.0 $\mu$ s        | 5.0 Vp-p       |
| U9 Pin 2   | Vsync         | 60.00 Hz         | 253.5 $\mu$ s      | 5.2 Vp-p       |

If the signals are good, replace the display assembly. If not, replace the system board.

- 6 Disconnect the LVPS ribbon cable from the display board.

**7 Measure the power supply voltages again (steps 1-3).**

If the voltages are within the test limits, replace the display assembly. If not, do the steps below.

- a** Disconnect the power cord.
- b** Disconnect the ribbon cable from the power supply.
- c** Connect the dummy load to the power supply connector.
- d** Connect the power cord, then measure the power supply voltages again (see new tolerances below).

+5.1 V (4.95 V to +5.25 V)

+15.75 V (+15 V to +16.5 V)

-15.75 V (-15 V to -16.5 V)

If the voltages are now within the test limits, replace the system board. If not, replace the power supply.

**8 Is the fan running?**

If yes, go to "To run the internal self-tests," on page 3-36. If not, do the steps below.

The LVPS has a thermal cut-out circuit. If the fan is defective, the LVPS shuts down when it gets too hot for safe operation.

- a** Disconnect the fan cable from the power supply.
- b** Measure the fan voltage at the connector on the power supply.

If the fan voltage is -8.3 Vdc, replace the fan. If not, replace the power supply.

---

## To check the LVPS (Low Voltage Power Supply)

- 1 Disconnect the power cord, then set the oscilloscope on its side.
- 2 Connect the negative lead of the multimeter to a ground point on the oscilloscope. Connect the power cord and turn on the oscilloscope.
- 3 Measure the power supply voltages at L3, L4, and L5 on the system board. See LVPS figure on page 3-23.

+5.1 V  $\pm$ 150 mV (+4.95 V to + 5.25 V)

+15.75 V  $\pm$ 787 mV (+14.96 V to +16.54 V)

-15.75 V  $\pm$ 787 mV (-14.96 V to -16.54 V)

If the +5.1 V measurement is out of the test limits, adjust the +5.1 V adjustment on the power supply. The  $\pm$ 15 V supplies are not adjustable and are dependent upon the +5.1 V supply.

### Blown fuse

If the fuse is blown in the power supply, the power supply is defective. Replace the power supply.

## To run the internal self-tests

- 1** Perform the keyboard test.
  - a** Press `Print/Utility`.
  - b** Press the `Self Tst` softkey, then press the `Keyboard` softkey.  
A pictorial diagram of the front panel will appear on the display.
  - c** Press each key, and notice that when you press a key a corresponding block on the display fills in.
  - d** Rotate the knobs (except the intensity) and notice that an arrow appears on the display that points in the direction you rotate the knob.
  - e** Do all the keys and knobs work?  
If yes, Press the `Stop` softkey two or three times (the display indicates how many times), then go to step 2. If not, replace the keyboard and keyboard assembly.

- 2** Check the output level of the DAC.
  - a** Press the DAC softkey.
  - b** Connect a multimeter to the rear panel DC CALIBRATOR connector.  
The multimeter should read  $0\text{ V} \pm 500\ \mu\text{V}$ .
  - c** Press any key to continue.  
The multimeter should read  $5\text{ V} \pm 10\text{ mV}$ .
  - d** Are the DAC voltages correct?  
If yes, press any key to continue. If not, replace the system board.
- 3** Perform the ROM test
  - a** Press the ROM softkey.
  - b** Does the display message say `Test Passed`?  
If yes, press any key to continue. If not, (the display message says `Test Failed`) replace the system board.

Service  
**Troubleshooting the Oscilloscope**

- 4** Perform the RAM test.
  - a** Press the RAM softkey.
  - b** Does the display message say Test Passed?  
If yes, press any key to continue. If not, (the display message says Test Failed) replace the system board.
- 5** Perform the display test.
  - a** Press  .
  - b** Press the Self Tst softkey, then press the Display softkey.
  - c** Do the half bright and full bright squares appear?  
If yes, continue with the steps below. If not, replace the display.
  - d** Press any key to continue.
  - e** Do squares appear in the four corners?  
If yes, the display is good. If not, replace the display.
  - f** Press any key to end the test.
  - g** If you still have the failing symptom, replace the system board.



---

## Replacing Parts in the Oscilloscope

This section contains instructions for removing and ordering replaceable assemblies. Also in this section is a parts list for the assemblies and hardware of the oscilloscope that you can order from Hewlett-Packard.

Before working on the oscilloscope, read the safety summary at the front of this book.

---

**WARNING**

---

Hazardous voltages are on the CRT, power supply, and display sweep board. To avoid electrical shock, disconnect the power cord from the oscilloscope. Wait at least three minutes for the capacitors in the oscilloscope to discharge before you begin disassembling the oscilloscope.

---

**CAUTION**

---

Do not replace assemblies with the oscilloscope turned on or damage to the components can occur.

## To replace an assembly

Refer to the exploded view of the oscilloscope, figure 3-8, for details on how the oscilloscope fits together. To install an assembly, follow the instructions in reverse order.

You will need the following tools to disassemble the oscilloscope:

- T15 TORX driver to remove the oscilloscope from the cabinet and to remove the fan.
- T10 TORX driver to remove the assemblies from the deck.
- Flat-blade screwdriver to remove the optional modules and the pouch.
- 9/16-inch nut driver or wrench to remove BNC nut.

### 1 Remove the oscilloscope from the cabinet.

- a Turn off the oscilloscope and disconnect the power cable.
- b If a module is installed, remove it from the oscilloscope.
- c Using the T15 TORX driver, remove the two screws from the rear of the cabinet.
- d Using your thumbs, gently push on the two rear-panel connectors to slide the oscilloscope out of the cabinet.

### 2 Remove the faulty assembly.

You can remove any of the following six assemblies: fan, front panel, display, system board, power supply, and keyboard.

Fan

- a Disconnect the fan cable from the power supply board.
- b Using the T15 TORX driver, remove the three screws that hold the fan to the deck.

Front panel

- a Remove the intensity knob by pulling straight out.
- b Disconnect the keyboard ribbon cable from the system board.
- c Remove the probe sense nuts.

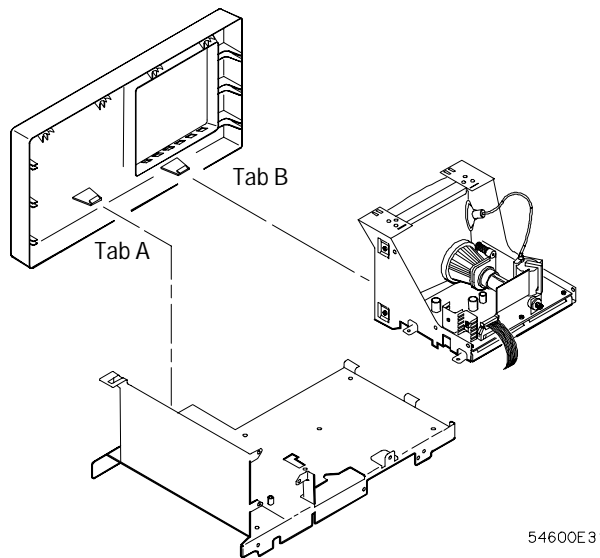
- d Use a screwdriver to release retainer tab A, and your finger to release retainer tab B. See figure 3-5.

**Releasing front panel from deck of instrument**

When tab B is released, be careful that the sheet metal tab of front-panel ground input clears the softkey circuit board. The circuit board may be depressed slightly with a screwdriver to avoid damage to the circuit board.

- e Rotate the front panel out until the bottom clears the rear of the assembly, then lift the front panel to free the hooks on top.  
Hint: When installing the front panel, make sure that the power switch shaft is aligned with its mating hole in the front panel.  
Hint: The front panel swings in to engage the two retainer tabs. Before attempting to engage the retainer tabs, make sure that the six hooks on top of the front panel are fully engaged with their mating holes in the sheet metal.

Figure 3-5



Service  
**Replacing Parts in the Oscilloscope**

Display

- a** Remove the front panel.
- b** Disconnect the ribbon cable and the calibration cable from the display.
- c** Using the T10 TORX driver, remove the two screws that hold the display to the deck.

Make sure that when you reinstall these screws that you use the correct parts. If longer screws are used, they can short the system board to ground.

- d** As you lift the display, rotate it off the two tabs on the side of the deck.

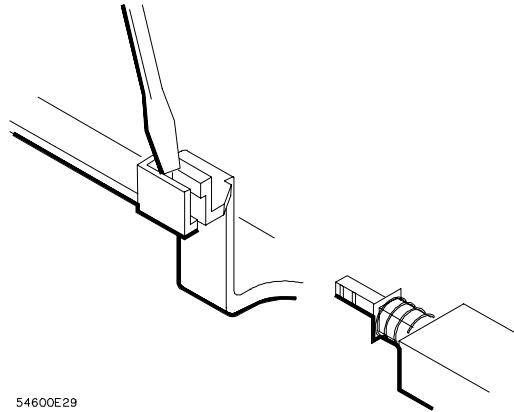
System board

- a** Using the T10 TORX driver, remove the eight screws that hold the system board to the deck (two of the screws are in the attenuator covers).
- b** Remove the two screws from the rear-panel interface connector and the nut from the rear-panel BNC.
- c** Disconnect the three ribbon cables and the calibration cable.
- d** As you remove the system board, rotate the system board so that the BNCs clear the front panel.

Power supply

- a Remove the fan.
- b Disconnect the ground wire (green wire with the yellow stripe) from the deck.
- c Disconnect the ribbon cable from the power supply board.
- d Use a screw driver to gently unhook the latch that holds the white shaft to the power switch, then disconnect the shaft from the power switch. After you disconnect the shaft, make sure you position it in the recess along the side of the display bracket.

Figure 3-6



- e Using the T10 TORX driver, remove the screw holding the power supply board to the deck.
- f Slide the power supply board towards the front panel about a half an inch. Slip the keyhole slots on the power supply board off of the pins on the deck.

Service  
**Replacing Parts in the Oscilloscope**

Keyboard

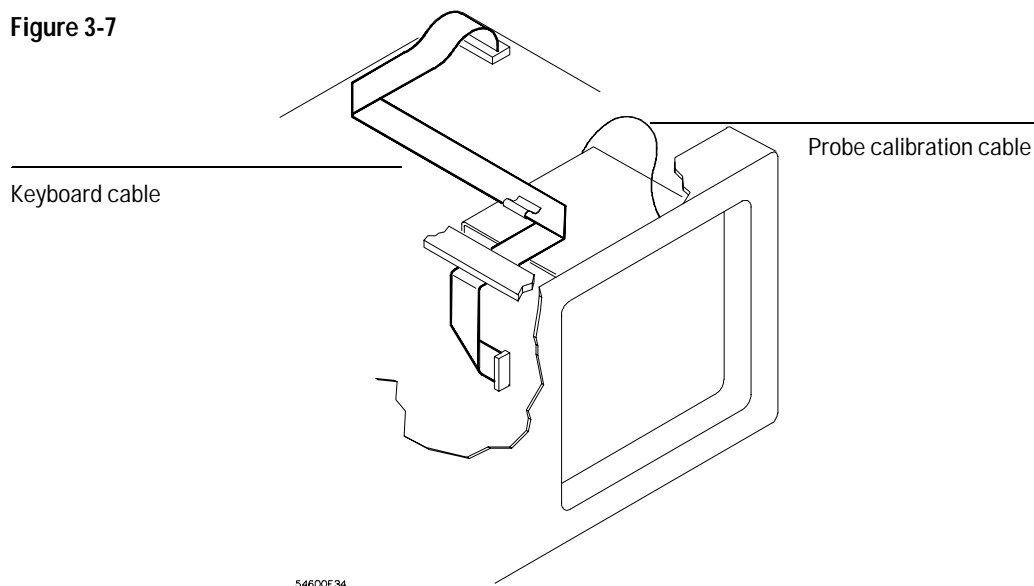
- a Remove the front panel.
- b Remove all the knobs by pulling straight out.
- c Flex the bezel of the front panel to unsnap the small keyboard under the display opening.
- d Using the T10 TORX driver, remove the three screws from the large keyboard.

Make sure that when you reinstall these screws that you use the correct parts. If longer screws are used, they can damage the front-panel label.

- e Press down on the top of the keyboard, and rotate the bottom of the keyboard out.

When installing the keyboard, make sure that the probe calibration cable is kept away from the keyboard cable or noise can occur in the probe adjust signal. See figure 3-7 for positioning the keyboard cable.

**Figure 3-7**



---

## To remove the handle

- Rotate the handle down until it is just past the last detent position (about 1/2 inch before the handle touches the bottom of the oscilloscope), then pull the sides of the handle out of the cabinet.

---

## To order a replacement part

The system board is part of an exchange program with Hewlett-Packard. The exchange program allows you to exchange a faulty assembly with one that has been repaired and performance verified by Hewlett-Packard.

After you receive the exchange assembly, return the defective assembly to Hewlett-Packard. A United States customer has 30 days to return the defective assembly. If you do not return the faulty assembly within the 30 days, Hewlett-Packard will charge you an additional amount. This amount is the difference in price between a new assembly and that of the exchange assembly. For orders not originating in the United States, contact your nearest Hewlett-Packard Sales Office for information.

## Replacing Parts in the Oscilloscope

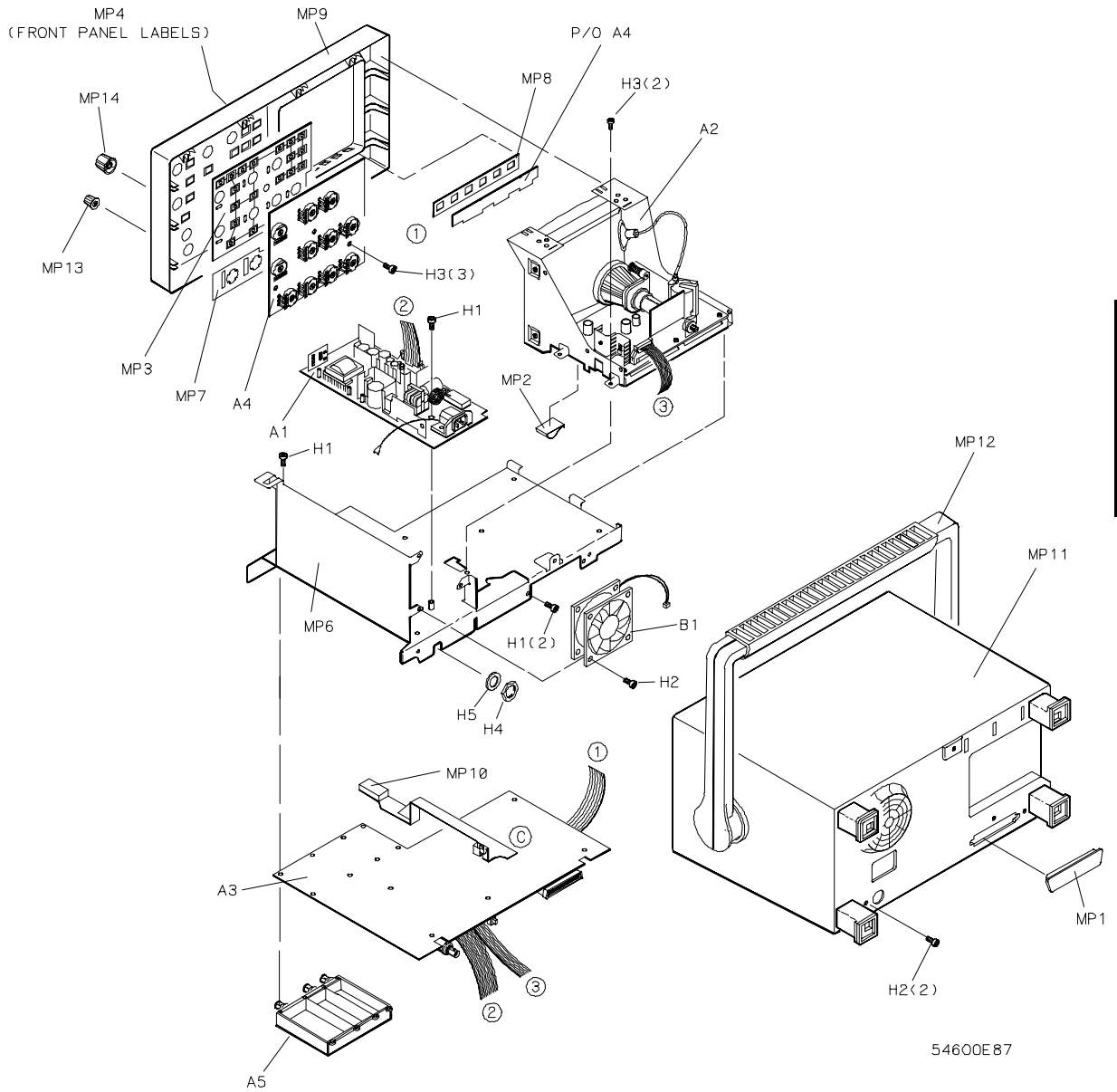
- To order a part in the material list, quote the Hewlett-Packard part number, indicate the quantity desired, and address the order to your nearest Hewlett-Packard Sales Office.
- To order a part not listed in the material list, include the model number and serial number of the oscilloscope, a description of the part (including its function), and the number of parts required. Address the order to your nearest Hewlett-Packard Sales Office.
- To order using the direct mail order system, contact your nearest Hewlett-Packard Sales office.

Within the USA, Hewlett-Packard can supply parts through a direct mail order system. The advantages to the system are, direct ordering and shipment from the HP Parts Center in Mountain View, California. There is no maximum or minimum on any mail order. (There is a minimum amount for parts ordered through a local Hewlett Packard Sales Office when the orders require billing and invoicing.) Transportation costs are prepaid (there is a small handling charge for each order) and no invoices.

In order for Hewlett-Packard to provide these advantages, a check or money order must accompany each order. Mail order forms and specific ordering information are available through your local Hewlett-Packard Sales Office. Addresses and telephone numbers are located in a separate document shipped with the instrument.



Figure 3-8



Exploded view of oscilloscope showing reference designators.

Service  
**Replacing Parts in the Oscilloscope**

**Table 3-14**

**Replaceable Parts**

| Reference Designator | HP Part Number | Qty | Description  |
|----------------------|----------------|-----|--|
| A1                   | 0950-2125      | 1   | Power supply assembly  |
| A2                   | 2090-0316      | 1   | Display assembly   |
| A3                   | 54610-66508    | 1   | System board<br>(includes A/D, but not attenuators)          |
| A3                   | 54610-69508    |     | Exchange system board<br>(includes A/D, but not attenuators) |
| A4                   | 54610-66504    | 1   | Keyboard   |
| A5                   | 54610-63401    | 1   | Attenuator assembly  |
| A5                   | 54610-69401    | 1   | Attenuator assembly, exchange                                |
| B1                   | 3160-0619      | 1   | Fan  |
| H1                   | 0515-0372      | 11  | Machine screw M3 X 8   |
| H2                   | 0515-0380      | 5   | Machine screw M4 X 10  |
| H3                   | 0515-0430      | 5   | Machine screw M3 X 6   |
| H4                   | 1250-2075      | 1   | RF connector nut, 0.5 inch                                   |
| H5                   | 2190-0068      | 1   | Lock washer  |
| MP1                  | 1251-2485      | 1   | Connector dust cover   |
| MP2                  | 1400-1581      | 1   | Cable clamp  |
| MP3                  | 54610-41901    | 1   | Large keypad   |
| MP4                  | 54610-94305    | 1   | Front-panel label  |
| MP5                  | 54610-94304    | 1   | Handle Label   |
| MP6                  | 54601-00101    | 1   | Deck   |
| MP7                  | 54601-07101    | 1   | EMI gasket   |
| MP8                  | 54601-41902    | 1   | Small rubber keypad  |
| MP9                  | 54601-42201    | 1   | Front panel  |
| MP10                 | 54601-43701    | 1   | Power-switch shaft   |
| MP11                 | 54601-64401    | 1   | Cabinet (comes with handle and feet installed)               |
| MP12                 | 54601-44901    | 1   | Handle   |

| Reference Designator | HP Part Number    | Qty | Description                                   |
|----------------------|-------------------|-----|---|
| MP13                 | 54601-47401       | 8   | Small knob                                    |
| MP14                 | 54601-47402       | 3   | Large knob                                    |
| MP15                 | 54601-47403       | 1   | Intensity knob                                |
| W1                   | 8120-1521         | 1   | Standard power cord                           |
| W1                   | 8120-1703         |     | Power cord option 900, United Kingdom         |
| W1                   | 8120-0696         |     | Power cord option 901, Australia              |
| W1                   | 8120-1692         |     | Power cord option 902, Europe                 |
| W1                   | 8120-0698         |     | Power cord option 904, 250 V, USA/Canada      |
| W1                   | 8120-2296         |     | Power cord option 906, Switzerland            |
| W1                   | 8120-2957         |     | Power cord option 912, Denmark                |
| W1                   | 8120-4600         |     | Power cord option 917, Africa                 |
| W1                   | 8120-4754         |     | Power cord option 918, Japan                  |
|                      | <b>10073A</b>     | 2   | <b>Passive probes, 10X</b>                    |
|                      | <b>Option 101</b> |     | <b>Accessory pouch and front-panel cover.</b> |
|                      | 5041-9411         |     | Pouch   |
|                      | 54601-44101       |     | Front-panel cover                             |

**Accessory replacement boards**

|             |                                  |
|-------------|----------------------------------|
| 54650-66502 | HP-IB interface module           |
| 54651-66502 | RS-232-C interface module        |
| 54652-66501 | Parallel output interface module |
| 54654-66501 | Training signal board            |



---

Performance  
Characteristics

---

# Performance Characteristics

The performance characteristics describe the typical performance of the new HP 54610 oscilloscope. You will notice that some of the characteristics are marked as tested, these are values that you can verify with the performance tests under "Verifying Oscilloscope Performance," on page 3-5.

---

## Vertical System

### Channels 1 and 2

Bandwidth<sup>1</sup>:

dc to 500 MHz -3 dB

ac coupled, 10 Hz to 500 MHz -3 dB

Rise time:

700 ps (calculated)

Dynamic range:  $\pm 12$  divisions

Math functions: Channel 1 + or - Channel 2

Input resistance: 1 M $\Omega$  or 50 $\Omega$  selectable

Input capacitance:  $\approx 8$  pf

Maximum input voltage: 250 V (dc + peak ac)



<sup>1</sup> Tested, see "To verify bandwidth," on page 3- 10.

Upper bandwidth reduced 2 MHz per degree C above 35°C

**Channels 1 and 2 (continued)**

Range: 2 mV/div to 5 V/div

Accuracy<sup>1</sup>:  $\pm 2.0\%$  of reading

Verniers<sup>1</sup>: Fully calibrated, accuracy  $\pm 2.0\%$  of reading

Cursor accuracy<sup>1, 2, 3</sup>:

    Single cursor accuracy: vertical accuracy  $\pm 1.2\%$  of full scale  $\pm 0.5\%$  of position value

    Dual cursor accuracy: vertical accuracy  $\pm 0.4\%$  of full scale

Bandwidth limit:  $\approx 30$  MHz

Coupling: Ground, ac, and dc

Inversion: Channel 1 and channel 2

CMRR (common mode rejection ratio):  $\approx 20$  dB at 50 MHz

Probe Sense: Automatic readout of 1X, 10X and 100X probes

<sup>1</sup> When the temperature is within  $\pm 10$  °C from the calibration range.

<sup>2</sup> Use a full scale of 80 mV for 2 mV/div and 5 mV/div ranges.

<sup>3</sup> Tested, see "To verify voltage measurement accuracy" on page 3-7.

## Horizontal System

Sweep speeds: 5 s/div to 1 ns/div main and delayed

Accuracy:  $\pm 0.01\%$  of reading

Vernier (Both main and delayed sweep): Accuracy  $\pm 0.05\%$  of reading

Horizontal resolution: 25 ps

Cursor accuracy<sup>1</sup> ( $\Delta t$  and  $1/\Delta t$ ):

$\pm 0.01\%$   $\pm 0.2\%$  of full scale  $\pm 200$  ps

Delay jitter: 10 ppm

Pretrigger delay (negative time):  $\geq 10$  divisions

Posttrigger delay (from trigger point to start of sweep):

The greater of 2560 divisions or 50 ms, but not to exceed 100 s.

Delayed sweep operation:

From 2 times up to 200 times main sweep

Delayed sweep can be as fast as 1 ns/div but must be at least 2 times main sweep.

Horizontal modes: Main, Delayed (Alt), X-Y, and Roll

<sup>1</sup> Tested, see "To verify horizontal  $\Delta t$  and  $1/\Delta t$  accuracy," on page 3-14.



---

## Trigger System

### Sources:

Channels 1, 2, line, and external

### Internal trigger

Sensitivity<sup>1</sup>:

dc to 25 MHz 0.35 div or 3.5 mV

dc to 500 MHz 1 div or 10 mV

Coupling: ac, dc, LF reject, HF reject, and noise reject

LF reject attenuates signals below 50 kHz, and

HF reject attenuates signals above 50 kHz

Modes: Auto, Autolevel, Normal, Single, and TV

TV triggering: Available on channels 1 and 2

TV line and field: 0.5 division of composite sync for stable display

Holdoff: Adjustable from 200 ns to  $\approx$ 13 s

### External trigger

Range:  $\pm$ 18 V

Sensitivity<sup>1</sup>:

dc to 25 MHz 50 mV

dc to 500 MHz 100 mV

Trigger View: External trigger input is displayed along with channel 1 and channel 2

Trigger View Bandwidth:  $\geq$  350 MHz

Coupling: ac, dc, LF reject, HF reject, and noise reject

Input resistance: 1 M $\Omega$  or 50 $\Omega$

Input capacitance:  $\approx$ 12 pf

Maximum input voltage: 250 V (dc + peak ac)



<sup>1</sup> Tested, see "To verify trigger sensitivity," on page 3-17.

**XY Operation**

---

## XY Operation

Operating mode: X=Ch 1, Y=Ch 2, Z=Ext. Trigger

Z Blanking: TTL high blanks trace

Bandwidths: X-axis and Y-axis same as vertical system

Z-axis is dc to 100 MHz

Phase difference:  $\pm 3$  degrees at 100 kHz

---

## Display System

Display: 7-inch raster CRT

Resolution: 256 vertical by 500 horizontal points

Controls: Front-panel intensity control

Graticule:  $8 \times 10$  grid or frame

Storage Scope: Autostore saves previous sweeps in half bright display and the most recent sweep in full bright display. This allows easy differentiation of current and historic information.

## Acquisition System

Maximum sample rate:

- 10 GSa/s for repetitive signals,
- 20 MSa/s for single shot signals on a single channel,
- and 10 MSa/s for single shot signals on dual channels

Resolution: 8 bits

Simultaneous channels: Channels 1 and 2

Record length:

- Vectors off: 4,000 points
- Vectors on and/or single shot: 2,000 points

Maximum update rate:

- Vectors off: 1,500,000 points/sec
- Vectors on: 60 full screens/sec, independent of the number of waveforms being displayed

Single-shot bandwidth: 2 MHz single channel, 1 MHz dual channel

Acquisition modes: Normal, Peak Detect, and Average

Peak detect: 50 ns glitch capture (100 ns dual channel)

Operates at sweep speeds of 50  $\mu$ s/div and slower

Average: Number of averages selectable at 8, 64, and 256

Roll Mode: At sweep speeds of 200 ms/div and slower, waveform data moves across the display from right to left with no dead time.

Display can be either free-running (non-triggered) or triggered to stop on a trigger event.

## Advanced Functions

Automatic measurements: (measurements are continuously updated)

Voltage: Vavg, Vrms, Vp-p, Vtop, Vbase, Vmin, Vmax

Time: Frequency, period, + width, – width, duty cycle, rise time, and fall time

Cursor Measurements: Four cursors can be positioned on the display to make time voltage measurements. The cursors will track changes in position and delay controls. Readout in V, T.

Setup functions:

Autoscale: Sets vertical and horizontal deflections and trigger level.

Requires a signal with a frequency  $\geq 50$  Hz, duty cycle  $> 1\%$  and voltage level channels 1 and 2  $> 20$  mVp-p, external trigger  $> 100$  mVp-p

Save/Recall: 16 front-panel setups can be stored and recalled from nonvolatile memory.

Trace memory: Two volatile pixel memories allow storage of multi-valued waveforms.

---

## Power Requirements

Line voltage range: 100 Vac to 250 Vac

Line voltage selection: Automatic

Line frequency: 45 Hz to 440 Hz

Maximum power consumption: 220 VA

---

## General

### Environmental characteristics

The instrument meets or exceeds the environmental requirements of MIL-T-28800D for Type III, Class 3, Style D equipment as described below.

Ambient temperature: (Tested to MIL-T-28800D paragraphs 4.5.5.13 option 2 and 4.5.5.14)

Operating:  $-10\text{ }^{\circ}\text{C}$  to  $+55\text{ }^{\circ}\text{C}$  ( $+14\text{ }^{\circ}\text{F}$  to  $+131\text{ }^{\circ}\text{F}$ )

Nonoperating:  $-51\text{ }^{\circ}\text{C}$  to  $+71\text{ }^{\circ}\text{C}$  ( $-60\text{ }^{\circ}\text{F}$  to  $+160\text{ }^{\circ}\text{F}$ )

Humidity: (tested to Hewlett-Packard environmental specification section 758 paragraphs 4.0, 4.1, and 4.2 for class B-1 products)

Operating: 95% relative humidity at  $+40\text{ }^{\circ}\text{C}$  ( $+104\text{ }^{\circ}\text{F}$ ) for 24 hours

Nonoperating: 90% relative humidity at  $+65\text{ }^{\circ}\text{C}$  ( $+149\text{ }^{\circ}\text{F}$ ) for 24 hours

Altitude: (Tested to MIL-T-28800E paragraph 4.5.5.2)

Operating: to 4,500 m (15,000 ft)

Nonoperating: to 15,000 m (50,000 ft)

### EMI

EMI (commercial) FTZ class B

EMI Meets the requirements in accordance with MIL-T-28800D

CE01: Part 2 narrow band requirements up to 15 kHz

CE03: Part 4

CS01: Part 2

CS02: Part 2

CS06: Part 5 limited to 300 V

RE01: Parts 5 and 6 measured at 12 inches, 15 dB relaxation to 20 kHz, and exceptioned from 20kHz to 50 kHz.

RE02: Part 2 (limited to 1 GHz) Full limits of class A1C and A1F, with option 002 installed

without option 002 installed 10 dB relaxation, 14 kHz to 1 GHz

RS02: Part 2, Part I

RS02: Part 2, Part II exceptioned

RS03: Part 2, limited to 1 V/meter from 14 kHz to 1 GHz

(with option 001 installed) Slight trace shift from 80 MHz to 200 MHz

## Performance Characteristics

### General

#### Vibration

Operating: 15 minutes along each of the 3 major axes; 0.025 inch p-p displacement, 10 Hz to 55 Hz in one-minute cycles. Held for 10 minutes at 55 Hz (4 g at 55 Hz).

#### Shock

Operating: 30 g, 1/2 sine, 11 ms duration, 3 shocks per axis along major axis. Total of 18 shocks.

#### Physical characteristics

Size (excluding handle)

Height 172 mm (6.8 in)

Width 322 mm (12.7 in)

Depth 317 mm (12.5 in)

Weight: 6.8 kg (15 lbs)

#### Product Regulations

**Safety** IEC 348  
CSA-C22.2 No.231 (Series M-89)

**EMC** This Product meets the requirement of the European Communities (EC) EMC Directive 89/336/EEC.

**Emissions** EN55011/CISPR 11 (ISM, Group 1, Class A equipment)  
SABS RAA Act No. 24 (1990)

| <b>Immunity</b> | EN50082-1              | Code <sup>1</sup> | Notes <sup>2</sup> |
|-----------------|------------------------|-------------------|--------------------|
|                 | IEC 801-2 (ESD) 8kV AD | 2                 |                    |
|                 | IEC 801-3 (Rad.) 3 V/m | 2                 |                    |
|                 | IEC 801-4 (EFT) 1kV    | 2                 |                    |

<sup>1</sup> Performance Codes:

1 PASS - Normal operation, no effect.

2 PASS - Temporary degradation, self recoverable.

3 PASS - Temporary degradation, operator intervention required.

4 FAIL - Not recoverable, component damage.

<sup>2</sup> Notes:  
(None)

**Sound Pressure Level** Less than 60 dBA

---

## Glossary

**50Ω Input Protection** This only functions when the scope is powered on. The 50Ω load will typically disconnect if greater than 5 Vrms is detected. However, the inputs could still be damaged, depending on the time constant of the signal.

**Auto** A trigger mode that produces a baseline display if the trigger conditions are not met. If the trigger frequency is less than 25 Hz, a free running display will result even if the level and slope conditions are met.

**Auto Level** The oscilloscope sets the trigger point to the 50% amplitude point on the displayed waveform. If there is no signal present, a baseline is displayed.

**Autoscale** Front-panel key that automatically sets up the oscilloscope to display a signal.

**Autostore** displays the stored waveforms in half bright, and the most recent trace is displayed in full bright.

**Baseline** Free running trace on the display when no signal is applied and the trigger mode is set to auto or auto level.

**BW Lim** (Bandwidth Limit) Limits the displayed bandwidth of the

selected channel to 30 MHz, and is available for channels 1 and 2 only. This feature is useful for viewing noisy signals

**Coupling** (Coupling) This changes the input coupling. Channels 1 and 2, and the External Trigger allow dc, ac, or ground.

**Cursors** Horizontal and vertical markers used for making custom voltage and time measurements.

**Delay** In main sweep, the delay knob moves the sweep horizontally, and indicates how far the time reference is from the trigger point. In delayed sweep the delay knob moves the starting point of the portion of the main sweep to be expanded by the delayed sweep.

**Delayed** Gives an expanded view of the main sweep.

**Deskewing** The removal of time offset errors between two signals. The error is typically due to differences in either cable lengths or characteristics. Also called Time Null.

**Display** Allows selection of either normal, peak detect, or averaged display modes.

**Erase** Clears the display.

**External Trigger** Extra input to the oscilloscope normally used for triggering. The external trigger is viewable on the HP 54610, allowing it to be used as an additional channel.

**Field 1** Triggers on the field 1 portion of the video signal.

**Field 2** Triggers on the field 2 portion of the video signal.

**HF Reject** (high frequency reject) Adds a low pass filter with a 3 dB point at 50 KHz to the trigger path.

**Holdoff** Keeps the trigger from rearming for an amount of time set by the holdoff knob.

**Internal Trigger** The oscilloscope triggers from a channel input that you choose.

**Invert** Invert changes the polarity of the waveform, and is available for channels 1 and 2. When the oscilloscope is triggered on the signal to be inverted, the trigger is also inverted.

**Level** Front-panel knob that changes the trigger level.

**LF Reject** (low frequency reject) Adds a high pass filter with a 3 dB point at 50 KHz to the trigger path.

**Line** In TV trigger mode, the oscilloscope triggers on the TV line sync pulses. As a trigger source, the oscilloscope triggers off of the power line frequency.

**Main** Sets the oscilloscope to a volts vs time display that displays the main time base sweep.

**Mode** Allows you to select one of five trigger modes, Auto level, Auto, Normal, Single, TV.

**Noise Rej** (noise reject) Decreases the trigger sensitivity to reduce the triggering on signal noise.

**Normal** If a trigger signal is present and the trigger conditions are met, a waveform is displayed. If there is no trigger signal, the oscilloscope does not trigger and the display is not updated.

**Peak Det** (peak detect) Allows detection of signal extremes as the sample rate is decreased in the 5 s to 50 ms/div time base settings.

**Polarity** Selects either positive or negative TV sync pulses.

**Position** Knob that moves the signal vertically on the display.



**Print/Utility** Allows access to the module menus and service menus.

**Probe** Allows selection of 1, 10, or 100 to match a probe's division ratio so that the vertical scaling and voltage measurements reflect the actual voltage levels at the tip of the probe.

**Probe Sense** Automatically detects the division ratio of the probe.

**Recall** Recalls a selected front-panel setup that you saved to one of 16 memory locations. Memory selection is with either a softkey or the knob closest to the Cursors front-panel key.

**Recall Setup** Recalls the front-panel setup that was saved with a waveform.

**Run** The oscilloscope acquires data and displays the most recent trace.

**Save** Saves the current front-panel setup to one of the possible 16 memory locations. Memory selection is with either a softkey or the knob closest to the Cursors front-panel key.

**Setup** Allows access to front-panel setup keys.

**Single** (single shot) The oscilloscope triggers once when the trigger conditions are met. The oscilloscope must be rearmed before the oscilloscope retriggers by pressing either the Run or Autostore front-panel keys.

**Skew** Time offset between two signals, typically due to differences in either cable lengths or characteristics.

**Slope/Coupling** Allows access to the trigger slope and input coupling menus.

**Slope** Selects either the rising or falling edge of the signal to trigger the oscilloscope.

**Source** Allows you to select a trigger source.

**Stop** Freezes the display.

**Time** Allows access to the automatic time measurement keys.

**Time/Div** Changes the time base in a 1-2-5 step sequence from 1 ns to 5 s.

**Time Null** The removal of time offset errors between two signals. The error is typically due to differences in either cable lengths or charac-

## Glossary

teristics. Also called deskewing.

**Time Ref Lft Cntr** (time reference left or center) Sets the time reference to either one graticule in from the left edge of the display or to center of the display.

**Trace** Allows access to the trace storage keys.

**Trace Mem** (trace memory) One of two pixel memory locations used for storing traces.

**TV** Allows access to the TV or video trigger keys.

**Vernier** Vernier allows a calibrated fine adjustment with the channel 1 and 2 Volts/Div knob, and the time base Time/Div knob.

**Voltage** Allows access to the automatic voltage measurement keys.

**Volts/Div** Changes the vertical scaling in a 1-2-5 step sequence from 2 mV to 5 V.

**XY** Changes the display to a volts versus volts display.

---

# Index

---

## A

ac coupling, 1-6, 1-10, 4-3, 4-5  
accuracy  
  cursors, 4-3 to 4-4  
  horizontal, 4-4  
  vertical, 4-3  
acquisition characteristics, 4-6  
Active Cursor, 2-23  
adjustments  
  display, 3-28 to 3-29  
  high frequency, 3-21 to 3-29  
  low frequency, 3-21 to 3-29  
  power supply, 3-22 to 3-23  
advance functions, 4-7  
altitude characteristics, 4-8  
ambient temperature, 3-21, 4-8  
assembly replacement, 3-40  
attenuation factor  
  of probe, 1-3  
Auto, 1-11  
auto level, 1-11  
Auto Level softkey, 1-11  
Auto softkey, 1-11  
automatic measurements  
  time, 2-16 to 2-18  
  voltage, 2-19 to 2-22  
automatic probe sensing, 1-3  
autoscale  
  characteristics, 4-7  
  to autoscale, 1-5  
  Undo, 1-5  
autostore, 2-6 to 2-7, 2-9 to 2-10  
Av, 2-33  
Average softkey, 2-33  
averaging, 2-33, 4-6

## B

bandwidth  
  characteristics, 4-2  
  limit, 4-3  
  single shot, 2-9, 4-6  
  to verify, 3-10  
  XY, 4-6

## C

calibration  
  adjustments, 3-21 to 3-29  
  delay, 3-25  
  self, 3-24 to 3-25  
  vertical, 3-25  
channel signal connection, 1-3  
characteristics, 4-2 to 4-9  
Clear Cursors softkey, 2-23  
Clear Meas softkey, 2-17  
clear measurement, 2-17  
Clear softkey, 2-38  
color burst, 2-37  
compensation probe, 1-4  
complex waveforms, 2-12  
coupling  
  ac, 1-6, 1-10, 4-3, 4-5  
  dc, 1-6, 1-10, 4-3, 4-5  
cursor measurements, 2-23 to 2-26  
Cursors  
  active, 2-23  
  clear, 2-23  
Cursors key, 2-23  
custom measurements, 2-23

## D

DAC softkey, 3-6  
DC Calibrator, 3-6, 3-24  
dc coupling, 1-6, 1-10, 4-5  
delay, 1-9  
delay calibration, 3-25  
Delay knobs, 2-3  
Delayed softkey, 2-3  
delayed sweep  
  characteristics, 2-3 to 2-5, 4-4  
  operation, 2-3 to 2-5, 2-11  
delta t/delta V  
  *See* cursor measurements  
disassembly, 3-40  
display  
  characteristics, 4-6  
  to adjust, 3-28 to 3-29  
  to erase, 2-8  
Display softkey, 3-28  
Duty Cy softkey, 2-17  
duty cycle, 2-16 to 2-17

## E

EMI, 4-9  
environmental characteristics, 4-8  
Erase softkey, 2-7 to 2-8  
erasing the display, 2-8  
exploded view, 4-47  
external trigger, 1-3, 1-12, 4-5

## F

fall time, 2-16, 2-18  
Field 1 softkey, 2-35  
Field 2 softkey, 2-35  
firmware calibration, 3-24  
Freq softkey, 2-14  
frequency  
  measurements, 2-14 to 2-15, 2-17  
  reject, 2-31 to 2-32, 2-35, 4-5  
front-panel keys  
  *See* keys listed by name

## G

general characteristics, 4-8 to 4-10  
glitch capture, 2-10 to 2-11

## H

half bright contrast, 3-29  
HF Rej softkey, 2-35  
high frequency pulse response, 3-26  
high frequency reject, 2-31, 2-35, 4-5  
holdoff, 1-12, 2-12  
Holdoff knob, 1-12  
horizontal  
  accuracy, 4-4  
  characteristics, 4-4  
  hold, 3-29  
  vernier, 1-9  
horizontal system, 1-9  
humidity characteristics, 4-8

## I

input  
  capacitance, 4-2, 4-5  
  coupling, 1-6, 1-10, 4-3, 4-5  
  maximum voltage, 1-3, 4-2, 4-5  
  resistance, 4-2, 4-5  
internal self tests, 3-36  
internal trigger, 4-5  
invert, 1-7, 4-3

## L

LF reject, 2-32  
 line  
   trigger, 1-10, 4-5  
   trigger (TV), 4-5  
 Line softkey  
   Source, 1-10  
   TV, 2-35  
 Load Defaults softkey, 3-24  
 low frequency  
   reject, 2-32, 2-35, 4-5

## M

main sweep, 2-3  
 Main/Delayed key, 2-3  
 marker  
   *See* cursor measurements  
 math functions, 4-2  
 maximum input voltage  
   trigger, 4-5  
   vertical, 4-2  
 measurement  
   automatic, 2-16 to 2-22  
   clear, 2-17  
   custom, 2-23  
   duty cycle, 2-16 to 2-17  
   fall time, 2-16, 2-18  
   frequency, 2-14 to 2-15, 2-17  
   period, 2-16 to 2-17  
   phase, 2-40 to 2-42  
   rise time, 2-16, 2-18  
   show, 2-15, 2-17  
   time, 2-16 to 2-18  
   width, 2-16  
 Mode key, 1-11

## N

narrow pulses, 2-10 to 2-11  
 negative time, 1-9  
 Next Menu softkey, 2-15, 2-17, 2-20  
 noise  
   asynchronous signal, 2-29 to 2-30  
   reject, 2-31  
 noise reject, 4-5

noisy signals  
   to remove from display, 2-31 to 2-33  
   to view, 2-29, 2-31 to 2-33  
 nonvolatile memory, 2-38  
 Normal softkey, 1-11

## O

one-channel acquisition, 2-9  
 oscilloscope maintenance, 3-5 to 3-19

## P

Peak Det softkey, 2-10  
 peak detect, 2-10  
 peak to peak voltage, 2-20  
 performance  
   tests, 3-5 to 3-19  
   verification, 3-5 to 3-19  
 performance characteristics  
   horizontal, 4-4  
   posttrigger, 4-4  
   pretrigger delay, 4-4  
   vertical, 4-2 to 4-3  
 period measurements, 2-16 to 2-17  
 phase measurement, 2-40 to 2-42  
 physical characteristics, 4-9  
 Plot  
   *See* User's Guide for optional interface  
 module  
 Polarity softkey, 2-35  
 Position knob, 1-6  
 Power requirements, 4-7  
 power supply  
   to adjust, 3-22 to 3-23  
   voltage measurements, 3-23  
 Previous Menu softkey, 2-18  
 Print  
   *See* User's Guide for optional interface  
 module  
 probe  
   automatic sensing, 1-3  
   compensation, 1-4  
   connection, 1-3  
   trimmer capacitor, 1-4  
 Probe softkey, 1-3  
 pulse  
   measurements, 2-16 to 2-18  
 pulse parameters  
   *See* time measurements

## R

rearming trigger, 2-8  
 Recall Setup softkey, 2-38  
 recall waveforms, 2-38  
 reject  
   noise, 4-5  
 replacement  
   list, 3-48  
   parts, 3-45  
 rise time measurement, 2-16, 2-18  
 Rise Time softkey, 2-18  
 Roll  
   mode, 1-13  
   softkey, 1-13  
 Run, 2-7 to 2-8

## S

sample rate, 4-6  
 save  
   setups, 2-39  
   waveforms, 2-38  
 Save to softkey, 2-38  
 self-calibrations, 3-24 to 3-25  
 self-tests, 3-36  
 setup saving, 2-39  
 Show Meas softkey, 2-15, 2-17  
 signal  
   automatic display, 1-5  
   dc component, 1-6  
   noise, 2-29, 2-33  
 single  
   event, 2-8 to 2-9  
   trigger, 2-8 to 2-9  
 single shot  
   bandwidth, 2-9  
   event, 2-9  
 Single softkey, 2-8  
 Slope/Coupling key, 2-8  
 softkey, 1-2  
   *See* keys listed by name  
 Source softkey, 1-11, 2-14, 2-17, 2-20  
 specifications  
   *See* characteristics  
 status line, 1-2  
 Stop key, 2-7, 2-9  
 storage operation, 2-6 to 2-7  
 sub bright, 3-28  
 subtract waveforms, 4-2

- 
- sweep
    - delayed, 1-8 to 1-9, 4-4
    - main, 1-8 to 1-9, 4-4
    - roll, 1-13
    - speed, 1-8 to 1-9, 4-4
  - T**
  - temperature
    - characteristics, 4-8
    - warm up, 3-5, 3-21
  - test record, 3-20
  - time
    - negative, 1-9
  - time base
    - accuracy, 4-4
    - range, 1-8, 4-4
    - setup, 1-8 to 1-9
  - Time key, 2-14
  - time measurements
    - duty cycle, 2-16 to 2-18
    - fall time, 2-16 to 2-18
    - frequency, 2-16 to 2-18
    - period, 2-16 to 2-18
    - rise time, 2-16 to 2-18
    - width, 2-16 to 2-18
  - time reference, 2-4
  - Time/Div, 2-3
  - trace
    - memory, 2-38
    - recall, 2-38
    - softkey, 2-38
    - to save, 2-38
  - Trace Mem softkey, 2-38
  - trigger
    - characteristics, 4-5
    - complex waveforms, 2-12
    - external, 1-12, 4-5
    - holdoff, 1-12, 2-12
    - internal, 4-5
    - level, 1-10, 2-8
    - loss of, 1-11
    - maximum input voltage, 4-5
    - mode, 1-11 to 1-12
    - point, 1-9
    - posttrigger information, 1-9
    - pretrigger information, 1-9
    - rearming, 2-8
    - roll, 1-13
    - single, 2-8 to 2-9
    - slope, 2-8
    - source, 1-10, 1-12, 2-8
    - to verify, 3-17
    - TV, 1-11, 2-34, 2-37
    - TV mode, 2-35
  - troubleshooting the oscilloscope, 3-9
  - TV
    - trigger, 1-11, 2-34, 2-37
    - trigger mode, 2-35
    - trigger-both fields, 2-37
    - vertical sync, 2-37
  - TV softkeys, 1-11
  - two-channel acquisition, 2-9
  - V**
  - vernier
    - accuracy, 4-3 to 4-4
    - horizontal, 1-9, 4-4
    - vertical, 1-7
  - Vernier softkey, 1-7, 1-9
  - vertical
    - calibration, 3-25
    - characteristics, 4-2 to 4-3
    - linearity, 3-29
    - scaling, 1-7
    - sensitivity, 1-7
    - size, 3-29
    - step size, 1-7
    - sync, 2-37
    - window, 1-6 to 1-7
  - Vertical softkey, 3-25
  - video
    - trigger, 2-34, 2-37
    - waveforms, 2-34 to 2-37
  - VITS, 2-34
  - voltage
    - adjustment, 3-22
    - maximum input, 1-3, 4-2, 4-5
    - measurement accuracy, 3-7
    - measurements, 2-19 to 2-22
    - peak to peak, 2-20
    - Vavg, 2-20
    - Vbase, 2-22
    - vernier, 1-7
    - Vmax, 2-22
    - Vmin, 2-22
    - Vrms, 2-20 to 2-21
    - Vtop, 2-22
  - volts versus time, 2-40
  - volts versus volts, 2-40
  - Volts/Div knob, 1-7
  - W**
  - waveform
    - complex, 2-12
    - saving, 2-38
    - width, 2-16, 2-18
  - X**
  - XY
    - characteristics, 4-6
    - cursors, 2-40 to 2-44
    - display mode, 2-40 to 2-44
    - measurements, 2-42
  - XY softkey, 2-40
  - Z**
  - Z-blanking, 2-39
-



# DECLARATION OF CONFORMITY

according to ISO/IEC Guide 22 and EN 45014

**Manufacturer's Name:** Hewlett-Packard Company

**Manufacturer's Address:** 1900 Garden of the Gods Road  
Colorado Springs , CO 80901  
U.S.A.

## Declares, That the product

**Product Name:** Digitizing Oscilloscope

**Model Number(s):** HP 54610

**Product Options:** All

## Conforms to the following Product Specifications:

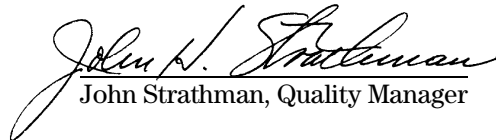
**Safety:** IEC 348 / HD 401  
UL 1244  
CSA - C22.2 No. 231 Series M-89

**EMC:** CISPR 11:1990 /EN 55011 (1991): Group 1 Class A  
IEC 801-2:1991 /EN 50082-1 (1992): 4 kV CD, 8 kV AD  
IEC 801-3:1984 /EN 50082-1 (1992): 3 V/m  
IEC 801-4:1988 /EN 50082-1 (1992): 1 kV

## Supplementary Information:

The product herewith complies with the requirements of the Low Voltage Directive 73/23/EEC and the EMC Directive 89/336/EEC.

Colorado Springs, July 5, 1993

  
John Strathman, Quality Manager

European Contact: Your local Hewlett-Packard Sales and Service Office or Hewlett-Packard GmbH,  
Department ZQ / Standards Europe, Herrenberger Strasse 130, 71034 Böblingen Germany (FAX: +49-7031-143143)

© Copyright Hewlett-Packard Company 1993, 1994  
All Rights Reserved.

Reproduction, adaptation, or translation without prior written permission is prohibited, except as allowed under the copyright laws.

#### Document Warranty

The information contained in this document is subject to change without notice.

**Hewlett-Packard makes no warranty of any kind with regard to this material, including, but not limited to, the implied warranties or merchantability and fitness for a particular purpose.**

Hewlett-Packard shall not be liable for errors contained herein or for incidental or consequential damages in connection with the furnishing, performance, or use of this material.

Complete product warranty information is given at the end of this manual.

#### Safety

This apparatus has been designed and tested in accordance with IEC Publication 348, Safety Requirements for Measuring Apparatus, and has been supplied in a safe condition. This is a Safety Class I instrument (provided with terminal for protective earthing). Before applying power, verify that the correct safety precautions are taken (see the following warnings). In addition, note the external markings on the instrument that are described under "Safety Symbols."

#### Warning

- Before turning on the instrument, you must connect the protective earth terminal of the instrument to the protective conductor of the (mains) power cord. The mains plug shall only be inserted in a socket outlet provided with a protective earth contact. You must negate the protective action by using an extension cord (power cable) without a protective conductor (grounding). Grounding one conductor of a two-conductor outlet is not sufficient protection.
- Only fuses with the required rated current, voltage, and specified type (normal blow, time delay, etc.) should be used. Do not use repaired fuses or short-circuited fuseholders. To do so could cause a shock of fire hazard.

- Service instructions are for trained service personnel. To avoid dangerous electric shock, do not perform any service unless qualified to do so. Do not attempt internal service or adjustment unless another person, capable of rendering first aid and resuscitation, is present.

- If you energize this instrument by an auto transformer (for voltage reduction), make sure the common terminal is connected to the earth terminal of the power source.

- Whenever it is likely that the ground protection is impaired, you must make the instrument inoperative and secure it against any unintended operation.

- Do not operate the instrument in the presence of flammable gasses or fumes. Operation of any electrical instrument in such an environment constitutes a definite safety hazard.

- Do not install substitute parts or perform any unauthorized modification to the instrument.

- Capacitors inside the instrument may retain a charge even if the instrument is disconnected from its source of supply.

- Use caution when exposing or handling the CRT. Handling or replacing the CRT shall be done only by qualified maintenance personnel.

#### Safety Symbols



Instruction manual symbol: the product is marked with this symbol when it is necessary for you to refer to the instruction manual in order to protect against damage to the product.



Hazardous voltage symbol.



Earth terminal symbol: Used to indicate a circuit common connected to grounded chassis.

#### WARNING

The Warning sign denotes a hazard. It calls attention to a procedure, practice, or the like, which, if not correctly performed or adhered to, could result in personal injury. Do not proceed beyond a Warning sign until the indicated conditions are fully understood and met.

#### CAUTION

The Caution sign denotes a hazard. It calls attention to an operating procedure, practice, or the like, which, if not correctly performed or adhered to, could result in damage to or destruction of part or all of the product. Do not proceed beyond a Caution symbol until the indicated conditions are fully understood or met.



---

## Product Warranty

This Hewlett-Packard product has a warranty against defects in material and workmanship for a period of three years from date of shipment. During the warranty period, Hewlett-Packard Company will, at its option, either repair or replace products that prove to be defective.

For warranty service or repair, this product must be returned to a service facility designated by Hewlett-Packard.

For products returned to Hewlett-Packard for warranty service, the Buyer shall prepay shipping charges to Hewlett-Packard and Hewlett-Packard shall pay shipping charges to return the product to the Buyer. However, the Buyer shall pay all shipping charges, duties, and taxes for products returned to Hewlett-Packard from another country.

Hewlett-Packard warrants that its software and firmware designated by Hewlett-Packard for use with an instrument will execute its programming instructions when properly installed on that instrument.

Hewlett-Packard does not warrant that the operation of the instrument software, or firmware will be uninterrupted or error free.

## Limitation of Warranty

The foregoing warranty shall not apply to defects resulting from improper or inadequate maintenance by the Buyer, Buyer-supplied software or interfacing, unauthorized modification or misuse, operation outside of the environmental specifications for the product, or improper site preparation or maintenance.

No other warranty is expressed or implied. Hewlett-Packard specifically

disclaims the implied warranties or merchantability and fitness for a particular purpose.

## Exclusive Remedies

The remedies provided herein are the buyer's sole and exclusive remedies. Hewlett-Packard shall not be liable for any direct, indirect, special, incidental, or consequential damages, whether based on contract, tort, or any other legal theory.

## Assistance

Product maintenance agreements and other customer assistance agreements are available for Hewlett-Packard products.

For any assistance, contact your nearest Hewlett-Packard Sales Office.

## Certification

Hewlett-Packard Company certifies that this product met its published specifications at the time of shipment from the factory. Hewlett-Packard further certifies that its calibration measurements are traceable to the United States National Institute of Standards and Technology, to the extent allowed by the Institute's calibration facility, and to the calibration facilities of other International Standards Organization members.

## About this edition

This is the first edition of the *HP 54610 Oscilloscope User and Service Guide*.

Publication number  
54610-97009

Printed in USA.

Edition dates are as follows:

First edition, March 1994

New editions are complete revisions of the manual. Update packages, which are issued between editions, contain additional and replacement pages to be merged into the manual by you. The dates on the title page change only when a new edition is published.

A software or firmware code may be printed before the date. This code indicates the version level of the software or firmware of this product at the time the manual or update was issued. Many product updates do not require manual changes; and, conversely, manual corrections may be done without accompanying product changes. Therefore, do not expect a one-to-one correspondence between product updates and manual updates.

The following list of pages gives the date of the current edition and of any changed pages to that edition.

All pages original edition